



ISOMETER® isoNAV685-D

AC/DC

Insulation Monitoring Device for IT AC systems
with galvanically connected rectifiers and inverters



PLEASE READ THIS MANUAL AND ANY ACCOMPANYING DOCUMENTS CAREFULLY AND KEEP THEM IN A SECURE PLACE FOR FUTURE REFERENCE.



Bender GmbH & Co. KG

Postfach 1161 • 35301 Gruenberg • Germany
Londorfer Straße 65 • 35305 Gruenberg • Germany

Tel.: +49 6401 807-0
Fax: +49 6401 807-259

E-Mail: info@bender.de
Web: www.bender.de

Customer service:
Service hotline: 0700-BenderHelp (Telephone and Fax)
Carl-Benz-Straße 8 • 35305 Gruenberg • Germany

Tel.: +49 6401 807-760
Fax: +49 6401 807-629

E-Mail: info@bender-service.com

© Bender GmbH & Co. KG
All rights reserved.
Reproduction only with permission
of the publisher.
Subject to change.!

1. Important information	6	6. Connection	16
1.1 How to use this manual	6	6.1 Connection requirements	16
1.2 Technical support	6	6.2 Connection to a 3(N)AC system	18
1.2.1 First level support	6	6.3 Connection to the X1 interface	18
1.2.2 Repair service	6	6.4 Connection to the supply voltage	19
1.2.3 Field service	7	6.5 Connection to the Ethernet interface	19
1.3 Training courses	7	6.6 Connection to the relay 1 interface (11 12 14)	20
1.4 Delivery conditions	7	6.7 Connection to the relay 2 interface (21 22 24)	20
1.5 Inspection, transport and storage	7	7. Commissioning	21
1.6 Disposal	7	7.1 General initial commissioning process	21
2. Safety instructions	8	7.2 Recommissioning	22
2.1 General safety instructions	8	8. Display	22
2.2 Work activities on electrical installations	8	8.1 Standard display	22
2.3 Device-specific safety information	8	8.2 Fault display (active)	23
2.4 Intended use	9	8.3 Fault display (inactive)	23
3. Function	10	8.4 Acknowledge fault memory	24
3.1 Features	10	8.5 Data-isoGraph	25
3.2 Product description	10	8.6 History memory	25
3.3 Functional description	10	8.7 Initial measurement	26
3.4 Interfaces	11	9. Menu	27
3.5 Self test	11	9.1 Menu structure	27
4. Device overview	12	9.2 Operating and navigating	28
4.1 Dimensions	12	9.2.1 Easy operation	28
4.2 Connections and panel	13		
4.3 Display elements and device buttons	14		
5. Mounting	15		
5.1 General instructions	15		
5.2 Screw mounting	15		
5.3 DIN rail mounting	16		

10. Settings	29
10.1 Settings in the device menu	29
10.1 (1.0) Alarm settings	29
10.1 (1.1) Insulation alarm	29
10.1 (1.1.1) Alarm 1	29
10.1 (1.1.2) Voltage	29
10.1 (1.1.3) t(on)	29
10.1 (1.1.4) Fault memory	29
10.1 (1.2) Profile	29
10.1 (1.3) System type	29
10.1 (1.4) Coupling	29
10.1 (1.5) Device	29
10.1 (1.6) T(Start)	29
10.1 (1.7) Coupling monitoring	30
10.1 (1.8) Inputs	30
10.1 (1.8.1) Digital 1	30
10.1 (1.8.1.1) Mode	30
10.1 (1.8.1.2) t(on)	30
10.1 (1.8.1.3) t(off)	30
10.1 (1.8.1.4) Function	31
10.1 (1.8.2) Digital 2	31
10.1 (1.8.3) Digital 3	31
10.1 (1.9) Outputs	31
10.1 (1.9.1) Relay 1	31
10.1 (1.9.1.1) TEST	31
10.1 (1.9.1.2) Relay mode	31
10.1 (1.9.1.3) Function 1	31
10.1 (1.9.1.4) Function 2	31
10.1 (1.9.1.5) Function 3	32
10.1 (1.9.2) Relay 2	32
10.1 (1.9.3) Digital 1	32
10.1 (1.9.3.1) Mode	32
10.1 (1.9.3.2) Function 1	32
10.1 (1.9.3.3) Function 2	32
10.1 (1.9.3.4) Function 3	32
10.1 (1.9.4) Digital 2	32
10.1 (1.9.5) Buzzer	32
10.1 (1.9.5.1) TEST	32
10.1 (1.9.5.2) Function 1	32

10.1 (1.9.5.3) Function 2	32
10.1 (1.9.5.4) Function 3	32
10.1 (1.9.6) Analogue	33
10.1 (1.9.6.1) Mode	33
10.1 (1.9.6.2) Midscale	33
10.1 (1.9.6.3) TEST	33
10.1 (1.9.6.4) Function	33
10.1 (2.0) Data measured values	34
10.1 (3.0) Control	34
10.1 (4.0) History	34
10.1 (5.0) Device settings	34
10.1 (5.1) Language	34
10.1 (5.2) Clock	34
10.1 (5.2.1) Time	34
10.1 (5.2.2) Format (time)	34
10.1 (5.2.3) Summer time	35
10.1 (5.2.4) Date	35
10.1 (5.2.5) Format (date)	35
10.1 (5.2.6) NTP	35
10.1 (5.2.7) NTP server	35
10.1 (5.2.8) UTC	35
10.1 (5.3) Interface	35
10.1 (5.3.1) Write access	35
10.1 (5.3.2) Ethernet	35
10.1 (5.3.2.1) DHCP	35
10.1 (5.3.2.2) IP	36
10.1 (5.3.2.3) SN	36
10.1 (5.3.2.4) Std. GW	36
10.1 (5.3.2.5) DNS server	36
10.1 (5.3.2.6) Domain	36
10.1 (5.3.3) BCOM	36
10.1 (5.3.3.1) System name	36
10.1 (5.3.3.2) Subsystem	36
10.1 (5.3.3.3) Device address	36
10.1 (5.3.3.4) Timeout	36
10.1 (5.3.3.5) TTL for subscription	36
10.1 (5.3.4) Modbus TCP	36
10.1 (5.3.4.1) Port 502	36
10.1 (5.3.5) BMS	36
10.1 (5.4) Display	36

10.1 (5.4.1) Brightness	36
10.1 (5.5) Password	36
10.1 (5.5.1) Password	36
10.1 (5.5.2) Status	37
10.1 (5.6) Commissioning	37
10.1 (5.7) Data backup	37
10.1 (5.8) Service	37
10.1 (6.0) Info	37
11. Device communication	38
11.1 Ethernet interface	38
11.2 BCOM	38
11.3 Modbus TCP	38
11.4 Web server	39
12. Device profiles	42
13. Diagrams	43
13.1 Response time profile power circuits	43
13.2 Response time profile inverter > 10 Hz	43
13.3 Response time profile inverter < 10 Hz	44
13.4 Relative uncertainty	44
14. Alarm messages	45
15. Factory settings	46
16. Technical data	47
16.1 Tabular data	47
16.2 Standards and certifications	50
16.3 Ordering details	50
17. Glossary	51

18. Modbus settings	52
18.1 General information	52
18.2 Data access by means of Modbus/TCP-Protokoll	52
18.2.1 Exception code	52
18.2.2 Modbus request	52
18.2.3 Modbus response	53
18.2.4 Structure of exception code	53
18.3 Measuring value information	53
18.3.1 High-byte test status	53
18.3.2 Low-byte alarm status	53
18.3.3 High-byte range	53
18.3.4 Low-byte unit	53
18.4 Modbus register assignment	55
Index	66

1.1 How to use this manual



This manual is intended for **qualified personnel** working in electrical engineering and electronics!

Always keep this manual within easy reach for future reference.

To make it easier for you to understand and revisit certain sections in this manual, we have used symbols to identify important instructions and information. The meaning of these symbols is explained below:



DANGER

This signal word indicates that there is a **high risk of danger** that will result in **electrocution** or **serious injury** if not avoided.



WARNING

This signal word indicates a **medium risk of danger** that can lead to **death** or **serious injury** if not avoided.



CAUTION

This signal word indicates a **low level risk** that can result in **minor or moderate injury** or **damage to property** if not avoided.



This symbol denotes information intended to assist the user in making **optimum use** of the product.

1.2 Technical support

For commissioning and troubleshooting Bender offers you:

1.2.1 First level support

Technical support by phone or e-mail for all Bender products

- Questions concerning specific customer applications
- Commissioning
- Troubleshooting

Telephone: +49 6401 807-760*

Fax: +49 6401 807-259

In Germany only: 0700BenderHelp (Tel. and Fax)

E-mail: support@bender-service.de

1.2.2 Repair service

Repair, calibration, update and replacement service for Bender products

- Repairing, calibrating, testing and analysing Bender products
- Hardware and software update for Bender devices
- Delivery of replacement devices in the event of faulty or incorrectly delivered Bender devices
- Extended guarantee for Bender devices, which includes an in-house repair service or replacement devices at no extra cost

Telephone: +49 6401 807-780** (technical issues)

+49 6401 807-784**, -785** (sales)

Fax: +49 6401 807-789

E-mail: repair@bender-service.de

Please send the devices for **repair** to the following address:

Bender GmbH, Repair-Service,
Londorfer Strasse 65,
35305 Grünberg

1.2.3 Field service

On-site service for all Bender products

- Commissioning, parameter setting, maintenance, troubleshooting for Bender products
- Analysis of the electrical installation in the building (power quality test, EMC test, thermography)
- Training courses for customers

Telephone: +49 6401 807-752**, -762 **(technical issues)
+49 6401 807-753** (sales)

Fax: +49 6401 807-759

E-mail: fieldservice@bender-service.de

Internet: www.bender-de.com

*Available from 7.00 a.m. to 8.00 p.m. 365 days a year (CET/UTC+1)

**Mo-Thu 7.00 a.m. - 8.00 p.m., Fr 7.00 a.m. - 13.00 p.m.

1.3 Training courses

Bender is happy to provide training regarding the use of test equipment.

The dates of training courses and workshops can be found on the Internet at www.bender-de.com -> Know-how -> Seminars.

1.4 Delivery conditions

Bender sale and delivery conditions apply.

For software products the "Softwareklausel zur Überlassung von Standard-Software als Teil von Lieferungen, Ergänzung und Änderung der Allgemeinen Lieferbedingungen für Erzeugnisse und Leistungen der Elektroindustrie" (software clause in respect of the licensing of standard software as part of deliveries, modifications and changes to general delivery conditions for products and services in the electrical industry) set out by the ZVEI (Zentralverband Elektrotechnik- und Elektronikindustrie e. V.) (German Electrical and Electronic Manufacturer's Association) also applies.

Sale and delivery conditions can be obtained from Bender in printed or electronic format.

1.5 Inspection, transport and storage

The devices must only be stored in areas where they are protected from dust, damp, and spray and dripping water, and in which the specified storage temperatures can be ensured.

1.6 Disposal

Abide by the national regulations and laws governing the disposal of this device. Ask your supplier if you are not sure how to dispose of the old equipment.

The directive on waste electrical and electronic equipment (WEEE directive) and the directive on the restriction of certain hazardous substances in electrical and electronic equipment (RoHS directive) apply in the European Community. In Germany, these policies are implemented through the "Electrical and Electronic Equipment Act" (ElektroG). According to this, the following applies:

- Electrical and electronic equipment are not part of household waste.
- Batteries and accumulators are not part of household waste and must be disposed of in accordance with the regulations.
- Old electrical and electronic equipment from users other than private households which was introduced to the market after 13 August 2005 must be taken back by the manufacturer and disposed of properly.

For more information on the disposal of Bender devices, refer to our homepage at www.bender-de.com -> Service & support.

2.1 General safety instructions

Part of the device documentation in addition to this manual is the enclosed "Safety instructions for Bender products".

2.2 Work activities on electrical installations



Only **qualified personnel** are permitted to carry out the work necessary to install, commission and run a device or system.



DANGER

Risk of electrocution due to electric shock!

Touching live parts of the system carries the risk of:

- An electric shock
- Damage to the electrical installation
- Destruction of the device

Before installing and connecting the device, make sure that the installation has been de-energised. Observe the rules for working on electrical installations.

If the device is used outside the Federal Republic of Germany, the applicable local standards and regulations must be complied with. The European standard EN 50110 can be used as a guide.

2.3 Device-specific safety information



WARNING

Make sure that the basic settings meet the requirements of the IT system. Children and unauthorised persons must not have access to or contact with the ISOMETER®.



CAUTION

Make sure that the operating voltage is correct!

Prior to insulation and voltage tests, the ISOMETER® must be disconnected from the IT system for the duration of the test. In order to check the correct connection of the device, a functional test has to be carried out before starting the system.



In the event of an alarm message of the ISOMETER®, the insulation fault should be eliminated as quickly as possible.



If the ISOMETER® is installed inside a control cabinet, the insulation fault message must be audible and/or visible to attract attention.



When using ISOMETER®s in IT systems, make sure that only one active ISOMETER® is connected in each interconnected system. If IT systems are interconnected via coupling switches, make sure that ISOMETER®s not currently used are disconnected from the IT system and deactivated. IT systems coupled via diodes or capacitances may also influence the insulation monitoring process so that a central control of the different ISOMETER®s is required.



Prevent measurement errors!

When a monitored IT system contains galvanically coupled DC circuits, an insulation fault can only be detected correctly if the rectifier valves (e.g. rectifier diode, thyristors, IGBTs, frequency inverters, ...) carry a minimum current of > 10 mA.



Unspecified frequency range

When connecting to an IT system with frequency components below the specified frequency range, the response times and response values may differ from the indicated technical data. However, depending on the application and the selected measurement method, continuous insulation monitoring is also possible in this frequency range.

There is no influence on the insulation monitoring for IT systems with frequency components above the specified frequency range, e.g. within the range of typical switching frequencies of frequency inverters (2...20 kHz).

2.4 Intended use



Only **qualified personnel** are permitted to carry out the work necessary to install, commission and run a device or system.

The ISOMETER® isoNAV685-D monitors the insulation resistance of unearthed AC main circuits (IT systems) with input voltages of AC 0...690 V and a frequency of 60 Hz in the three-phase network.

DC components existing in AC/DC systems do not influence the operating characteristics. Due to the separate supply voltage, de-energised systems can also be monitored. The maximum permissible system leakage capacitance is 0...150 µF, depending on the profile.

Intended use also implies:

- The observation of all information in the operating manual
- Compliance with test intervals

In order to meet the requirements of applicable standards, customised parameter settings must be made on the equipment in order to adapt it to local equipment and operating conditions. Please heed the limits of the area of application indicated in the technical specifications.

Any other use than that described in this manual is regarded as improper.

3.1 Features

- ISOMETER® for IT AC systems with galvanically connected rectifiers or inverters and for IT DC systems (IT = unearthed systems).
- Automatic adaptation to the existing system leakage capacitance.
- Combination of **AMPPlus®** and other profile-specific measurement methods.
- An adjustable response value for insulation monitoring in the range of 1 kΩ...10 MΩ (factory setting = 5 kΩ) and a response value of 150 V for the DC offset voltage.
- High-resolution graphic LC display for excellent readability and recording of the device status.
- Connection monitoring (monitoring of the measuring lines).
- Automatic device self test.
- History memory with real-time clock (buffer for three days) for storing 1023 alarm messages with date and time.
- Current and voltage output 0(4)...20 mA, 0...400 µA, 0...10 V, 2...10 V (galvanically separated) which is analogous to the measured insulation value of the system.
- Freely programmable digital inputs and outputs.
- Remote setting via the Internet or Intranet (Webserver / Option: COMTRAXX® Gateway).
- Worldwide remote diagnosis via the Internet (made available by Bender Service only)
- BCOM, Modbus TCP and web server

3.2 Product description

The ISOMETER® isoNAV685-D is an insulation monitoring device in accordance with IEC 61557-8 for IT systems. It is applicable for use in 3(N)AC systems.

3.3 Functional description

The insulation monitoring device ISOMETER® isoNAV685-D-B continuously monitors the entire insulation resistance of an IT system during operation and gives a warning within 150 ms as soon as the insulation resistance falls below the set response value and the DC offset voltage exceeds the response value. Because of these characteristics, the ISOMETER® can, for example, quickly shut down a plant.

To obtain a measurement the device has to be connected between the IT system (unearthed system) and the protective earth conductor (PE). A measuring current in the µA range is superimposed onto the system which is recorded and evaluated by a micro-controlled measuring circuit. The measuring time is dependent on the selected measurement profiles, the system leakage capacitance, the insulation resistance and possible system-related disturbances.

The response values and other parameters are set using a commissioning wizard as well as via different setup menus using the device buttons and a high-resolution graphical LC display. The selected settings are stored in a permanent fail-safe memory. Different languages can be selected for the setup menus as well as the messages indicated on the display. The device utilises a clock for storing fault messages and events in a history memory with time and date stamp. The settings can be protected against unauthorised modifications by entering a password. To ensure proper functioning of connection monitoring, the device requires the setting of the system type 3AC and the prescribed wiring of the appropriate terminals

L1/+, L2, L3/-.

The insulation monitoring device iso685 is able to measure the insulation resistance reliably and precisely in all common IT systems (unearthed systems). Due to various applications, system types, operating conditions, application of variable-speed drives, high system leakage capacitances etc., the measurement technique must be able to meet varying requirements in order to ensure an optimised response time and relative uncertainty. Different measurement profiles, which can be selected from a setup menu, allow optimum adaptation of the measurement technique to the specific application.

If the resistance value falls below a set response value R_{an} , the associated alarm relay turns off, the LED ALARM 1 lights and the LCD shows the measured value. The error message is saved. Pressing the RESET button resets the insulation fault message, provided that the insulation resistance is at least 25 % above the preset response value. As additional information, the quality of the measuring signal and the time required to update the measured value are shown on the display. A poor signal quality (1-2 bars) may be an indication that the wrong measurement profile has been selected.

3.4 Interfaces

- Communication protocol Modbus TCP
- BCOM for Bender device communication via Ethernet
- Integrated web server for reading out measured values and for parameter setting

3.5 Self test

After switching on the supply voltage, the ISOMETER® automatically and continuously checks all internal measuring functions, the components of the process control such as the data and parameter memory, as well as the connections to the IT system and earth.

The self test can also be activated manually by means of the test button to check the functions of the relays (depending on the configuration) or it can be selected via the "Control" menu (refer to ["Control" on page 34](#)).

The progress of the manual self test is shown on the LC display by a bar graph. Depending on the conditions in the IT system being monitored, the self test is completed after 15...20 seconds. The device then returns to the standard mode (measurement mode) and the actual measured value will be displayed after the measuring time has expired. The display shows the message `Initial measurement` until the first valid value is measured (refer to ["Initial measurement" on page 26](#)).

If a fault is detected during the self test, the respective LEDs of the device light (refer to ["Alarm messages" on page 45](#)). In addition, the respective message will be indicated on the display and a previously programmed output will provide the respective signal.

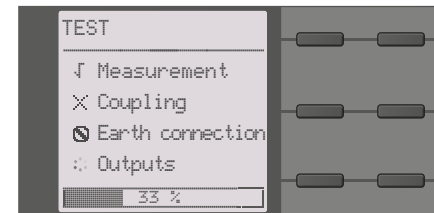

The test has been run and the result was positive.



The test has been run and the result was negative.



The test is not available and is not carried out (e.g. due to specific device settings).



The test is running.

4. Device overview

4.1 Dimensions

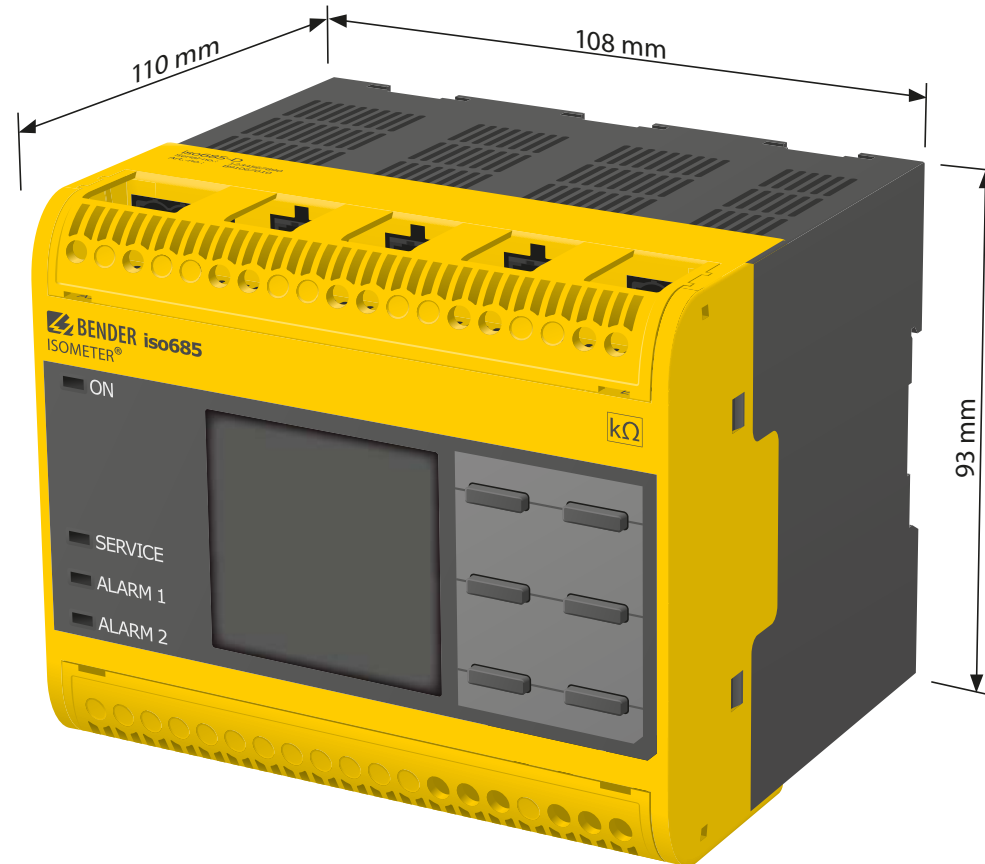

4.2 Connections and panel

Top

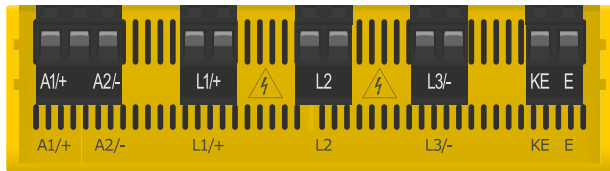

A1/+, A2/-
L1/+
L2
L3/-
KE, E

Connection to the power supply voltage U_s
Connection to the IT system to be monitored
Connection to the IT system to be monitored
Connection to the IT system to be monitored
Connection to PE

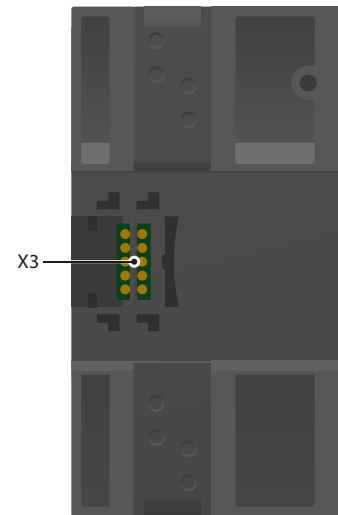
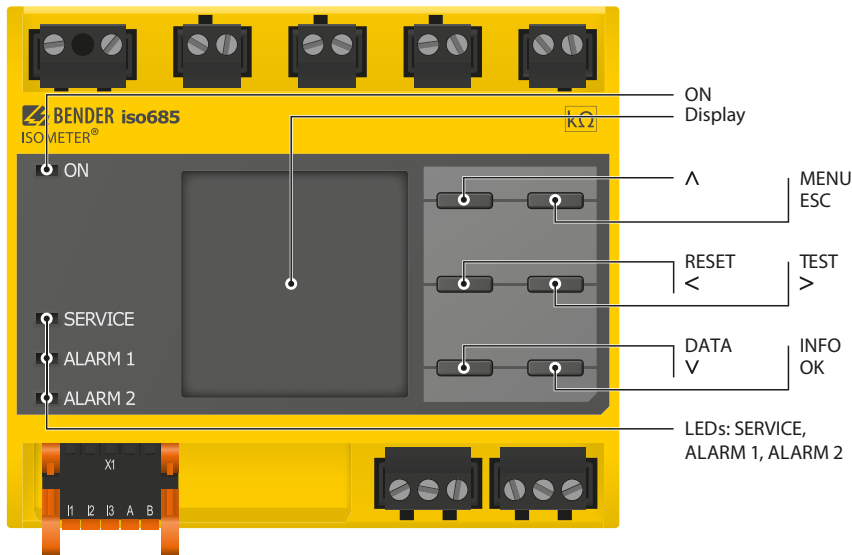

Bottom

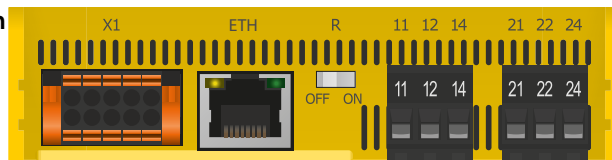

X3

Optional expansion module for Bender devices (e. g. BB-Bus)

X1
ETH
R
11 12 14
21 22 24

Digital interface
Ethernet interface
Selectable resistance R
Connector for alarm relay 1
Connector for alarm relay 2

4.3 Display elements and device buttons

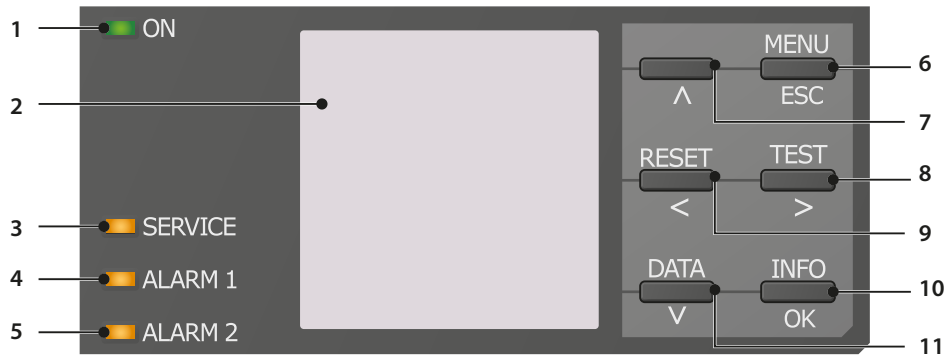

Display elements

1	ON	The LED "ON" lights when the device is turned on.
2		The device display shows information regarding the device and the measurements. Other information is available in the chapter "Display" from page 22.
3	SERVICE	The LED "SERVICE" lights when there is either a device fault or a connection fault, or when the device is in maintenance mode.
4	ALARM 1	The LED "ALARM 1" lights when the insulation resistance of the IT system falls below the set response value R_{an1} .
5	ALARM 2	The LED "ALARM 2" lights when the insulation resistance of the IT system falls below the set response value R_{an2} and the DC offset voltage exceeds the response value.

Device buttons

You can adjust the device settings in the respective menu using the menu buttons. Depending on the menu entry, one of the options displayed below is assigned to the buttons.

6	MENU	Opens the device menu.
7	ESC	Cancels the current process or navigates one step back in the device menu.
8	^	Navigates up in a list or increases a value.
9	TEST	Starts the device self test.
10	>	Navigates forwards (e.g. to the next setting step) or selects a parameter.
11	RESET	Resets alarms.
	<	Navigates backwards (e.g. to the previous setting step) or selects a parameter.
	Info	Shows information.
	OK	Confirms an action or a selection.
	DATA	Indicates data and values.
	v	Navigates down in a list or reduces a value.

5.1 General instructions



Only **qualified personnel** are permitted to carry out the work necessary to install, commission and run a device or system.



DANGER

Risk of electrocution due to electric shock!

Touching live parts of the system carries the risk of:

- An electric shock
- Damage to the electrical installation
- Destruction of the device

Before installing and connecting the device, make sure that the installation has been de-energised. Observe the rules for working on electrical installations.

5.2 Screw mounting

19. Fix the three mounting clips delivered with the device (two of them packed separately) manually or using a tool, as illustrated below.
20. Drill the mounting holes for the M4 thread according to the dimensioned drilling template.
21. Fix the ISOMETER® using three M4 screws.

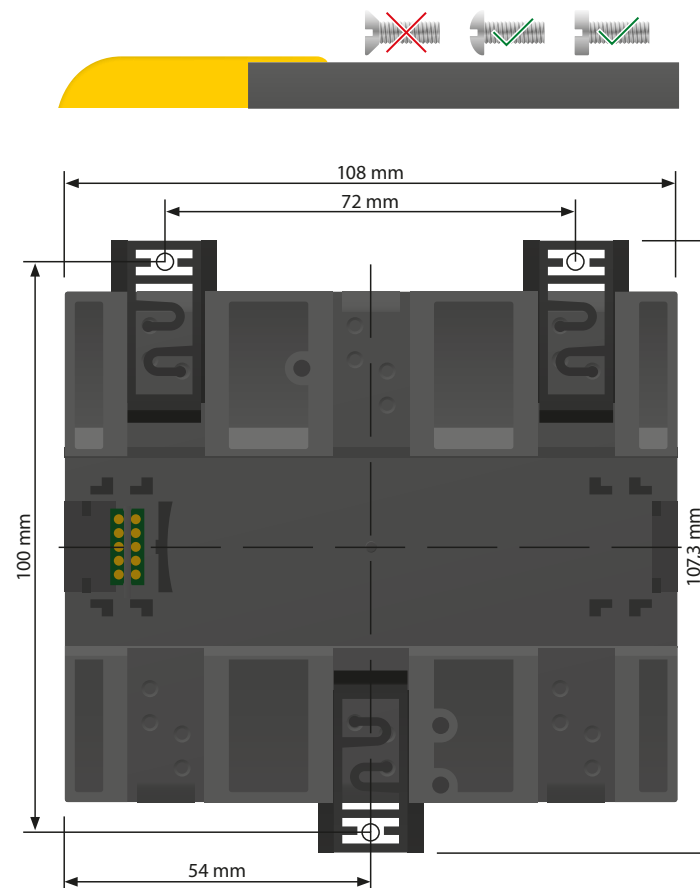

5.3 DIN rail mounting

1. Fix the three mounting clips delivered with the device (two of them packed separately) manually or using a tool, as illustrated below.
2. Fix the ISOMETER® onto the DIN rail until it snaps into place.

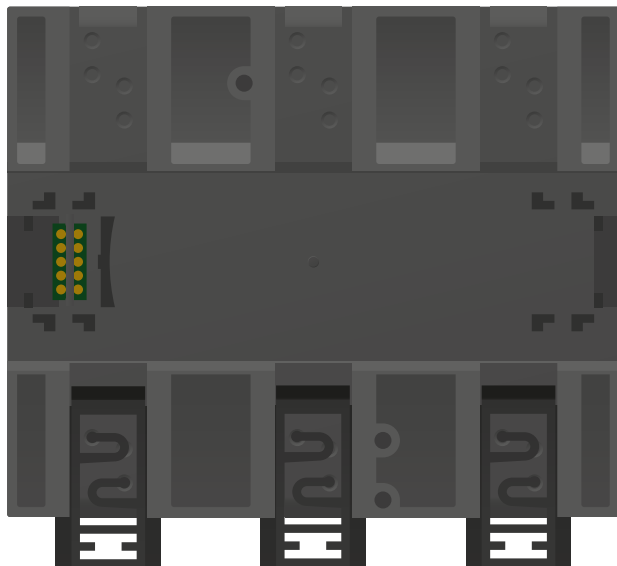

6. Connection

6.1 Connection requirements

Consider the minimum distance to adjacent devices:
lateral 0 mm, top 20 mm, bottom 20 mm.



Only **qualified personnel** are permitted to carry out the work necessary to install, commission and run a device or system.



DANGER

Risk of electrocution due to electric shock!

Touching live parts of the system carries the risk of:

- An electric shock
- Damage to the electrical installation
- Destruction of the device

Before installing and connecting the device, make sure that the installation has been de-energised. Observe the rules for working on electrical installations.



DANGER

Risk of electric shock!

Nominal voltages up to 1000 V may be present on the terminals L1/+ to L3/- which can be lethal. Make sure the terminal covers are properly mounted and clicked in before putting the device into operation.



DANGER

Risk of electric shock!

High voltage is applied at the terminals, which in case of direct contact can be life-threatening. If the terminals L1/+, L2, L3/- of the device are connected to a live IT system, the terminals E and KE must not be disconnected from the protective conductor (PE).



WARNING

Warning of insulation monitoring devices that do not work correctly!

Connect the terminals KE and E individually to the protective earth conductor PE.

**Provide line protection!**

According to DIN VDE 0100-430, a line protection shall be provided for the supply voltage.

**Risk of injury from sharp-edged terminals!**

Risk of lacerations.
Touch the enclosure and the terminals with due care.

**Ensure disconnection from the IT system!**

When insulation or voltage tests are to be carried out, the device must be isolated from the system for the test period. Otherwise the device may be damaged.

**Risk of property damage due to unprofessional installation!**

If more than one insulation monitoring device is connected to a conductively connected system, the system can be damaged. If several devices are connected, the device does not function and does not signal insulation faults. Make sure that only **one** insulation monitoring device is connected in each conductively connected system.

**Risk of property damage due to unprofessional installation!**

The connecting lines L1+, L2, L3/- to the system to be monitored must be carried out as spur lines. Inadmissible load current can result in damage to property and personal injury. Do not apply any load current to the terminals.

**Check proper connection!**

Prior to commissioning of the installation, check that the device has been properly connected and check the device functions. Perform a functional test using an earth fault via a suitable resistance.

**Prevent measurement errors!**

When an AC system being monitored contains galvanically coupled DC circuits, take into consideration that: an insulation fault can only be detected correctly when the rectifier valves carry a minimum current of >10 mA.

**For UL applications:**

Use 60/70 °C copper lines only!
For UL and CSA applications, the supply voltage must be protected via 5 A fuses.

6.2 Connection to a 3(N)AC system



WARNING

Risk of injury, fire and damage to property due to a short circuit!

According to DIN VDE 0100-430, devices used to protect against a short circuit when terminals L1/+, L2 and L3/- are coupled to the IT system to be monitored can be omitted if the wiring is carried out in such a manner as to reduce the risk of a short circuit to a minimum. Ensure short-circuit-proof and earth-fault-proof wiring.

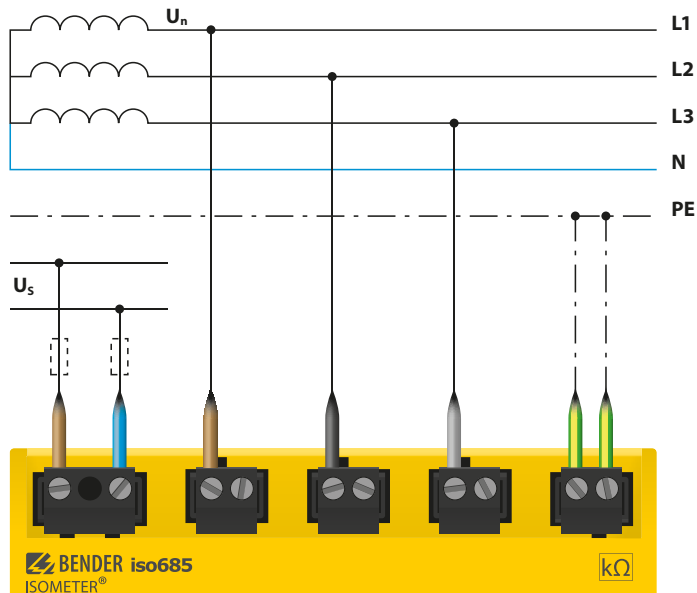

Position the terminal cover and click it into place

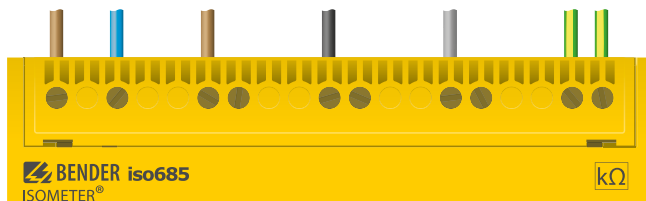

6.3 Connection to the X1 interface

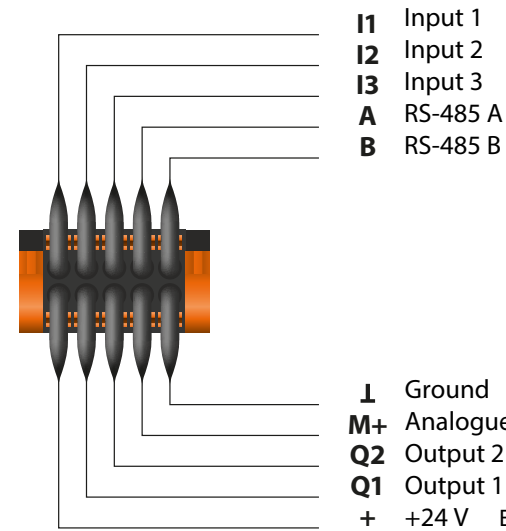

Position the terminal cover and click it into place



6.4 Connection to the supply voltage



External Power supply for powering the ISOMETER® via terminal X1 must fulfil immunity and emission standards of the required application. For wiring longer than 1 m the use of a shielded cable is prescribed.



CAUTION

Danger of damage to property due to faulty connections!
The device can be damaged if the unit is simultaneously connected to the supply voltage via the X1 interface, and A1/+ and A2/- terminals. Do not connect the device simultaneously via X1, and A1/+ and A2/- to different supply voltages.

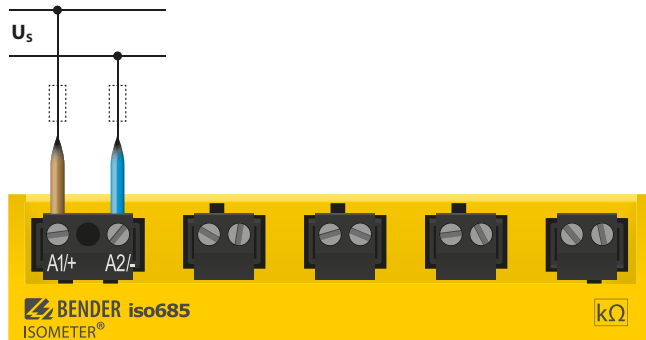

6.5 Connection to the Ethernet interface

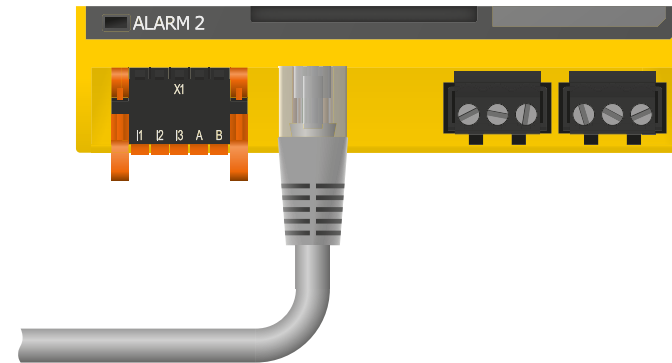

Position the terminal cover and click it into place

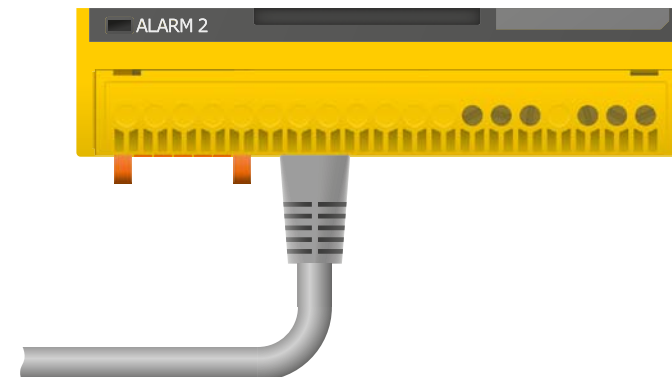

6.6 Connection to the relay 1 interface (11 12 14)

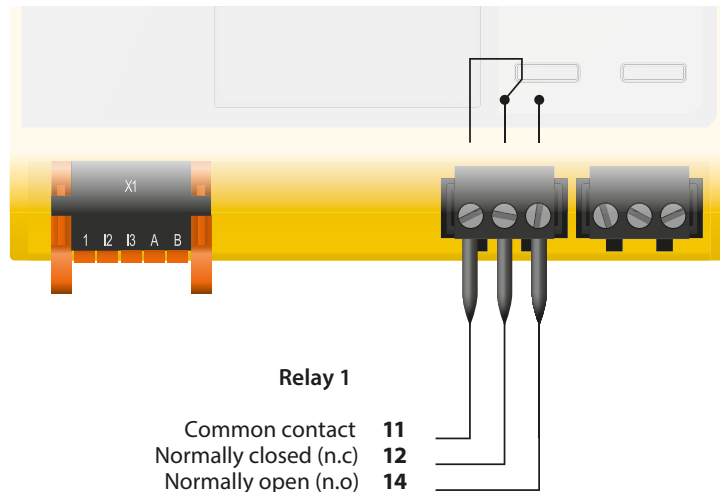

Position the terminal cover and click it into place

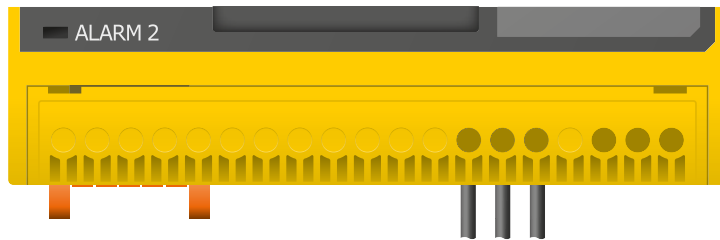

6.7 Connection to the relay 2 interface (21 22 24)

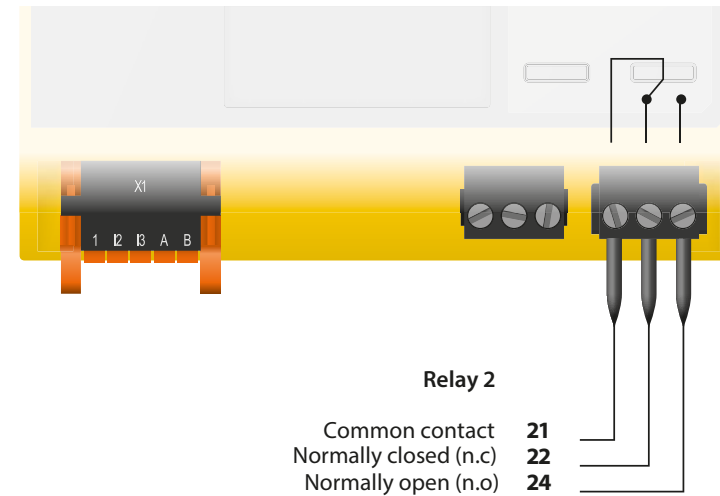

Position the terminal cover and click it into place



7.1 General initial commissioning process

1. Check that the ISOMETER® is properly connected to the system to be monitored.
2. Connect the supply voltage to the ISOMETER®. Adjust the device using the commissioning wizard. Afterwards, the ISOMETER® performs a self test in four steps. The alarm relays are not checked during this test. After completion of the test, the measured insulation resistance is shown on the display. If the value exceeds the response values indicated in the lowest line of the display, the message "OK" will additionally be displayed.



For customer-specific configured devices, the commissioning wizard might be deactivated and cannot be run. In this case, the device is preset. However, the commissioning wizard can be started as described at ["Recommissioning" on page 22](#).

3. Check the ISOMETER® in the system being monitored, e.g. using a suitable resistance to earth.



Observe device status!

The device is in an alarm state until initial commissioning has been completed.

After setting the response value R_{an} and the DC offset voltage, the device starts a self-test, makes the first measurement and outputs the measured insulation resistance values of the IT system being monitored, then commissioning is completed.

Commissioning flow chart

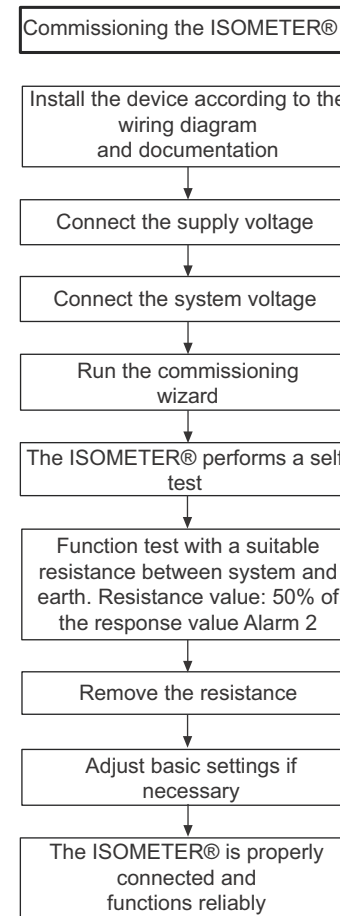

For further information regarding device settings, refer to chapter ["Settings" from page 29](#).

7.2 Recommissioning

If the device has already been put into operation before, the self test will be started shortly after the supply voltage has been connected. Start the commissioning wizard using the menu path:

Menu/Device settings/Commissioning

This menu can be used to modify settings made previously.



Observe the device status!

The device changes from the alarm state to normal state after completing initial commissioning and initial measurement by adhering to the response values set.

8. Display

8.1 Standard display

During normal operation, the ISOMETER® displays the message OK and below, the currently measured insulation resistance.



The signal quality of the measurement suits the selected profile. The better the signal quality, the faster and more exact the device can measure.



The signal quality of the measurement does not suit the selected profile. Select a different measurement profile.



Update period between the test pulses

In the bottom line of the display, the set limit values for R(an) are indicated. In the example shown below $R_{an}=5\text{ k}\Omega$.

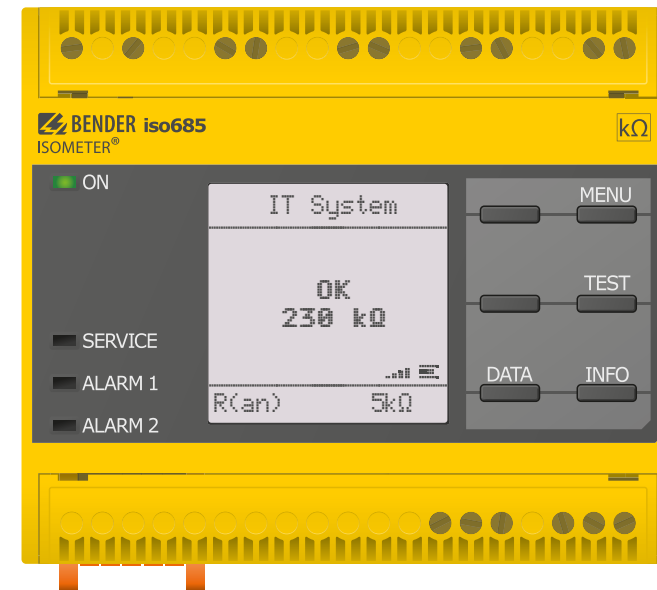

8.2 Fault display (active)

An active fault is displayed by . The upper part of the display will become orange and displays the fault message.

Depending on the type of fault, the LEDs ALARM 1, ALARM 2 or SERVICE are activated.

ALARM 1 lights	Insulation fault
ALARM 1 + 2 lights	Insulation fault + DC shift error
ALARM 1 + 2 blinks	Connection fault
SERVICE lights up	Device fault

In the example below, the insulation resistance is 3 kΩ. Because the measured insulation value is below the set response insulation resistance value of $R_{an}=5\text{ k}\Omega$ and the DC offset voltage response value of 150 V has been exceeded, Alarm 1 and Alarm 2 have been triggered. In addition, information concerning the DC-shift is also displayed.

If several fault messages occur, you can navigate through the faults using the ∇ and \wedge buttons.

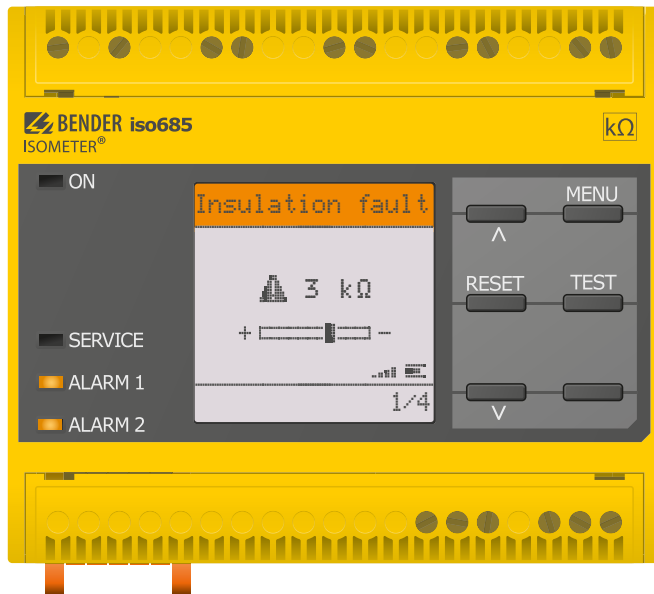

8.3 Fault display (inactive)

An inactive fault is displayed by . If several faults have occurred, the number of faults will also be indicated.

This message means that there has been a fault in the past but the device is no longer in fault condition.

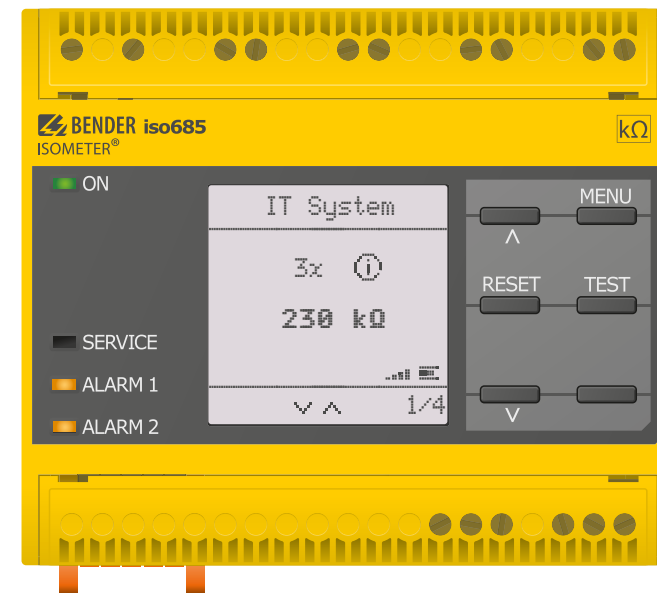

If several fault messages occur, navigate through the faults using the ∇ and \wedge button. In addition to the type of fault and the associated alarm value when the fault has occurred and how long it has been active will be shown.

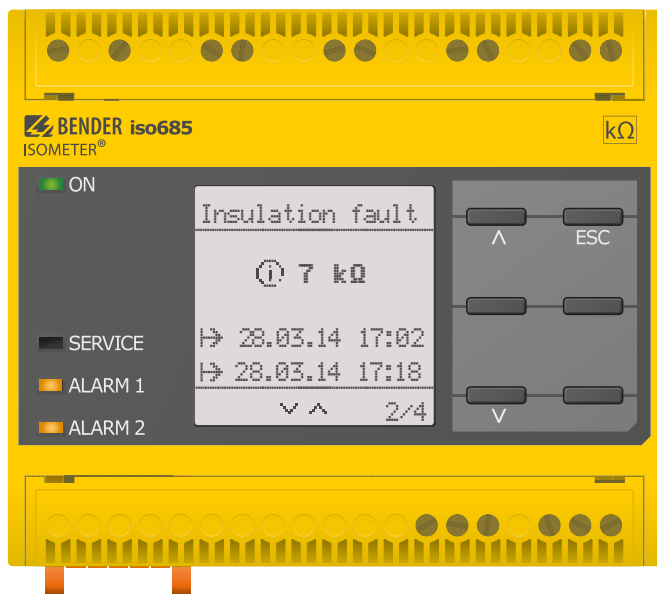

8.4 Acknowledge fault memory

In order to acknowledge the fault message and return to the ISOMETER®'s standard display, all faults must be acknowledged by means of the reset button.

This means that fault messages can only be reset when the cause of the fault has been eliminated.

Press the reset button, then \triangleright and OK to clear the fault memory. The ISOMETER® then returns to the standard display.



8.5 Data-isoGraph

The isoGraph represents the chronological sequence of the insulation resistance over time. This graphical representation can be displayed over the following time periods: hour, day, week, month and year.

The measured values for individual representations are stored in a separate memory. Up to 100 measured values are available to represent each graph. and the resolution of each graph is determined by these values.

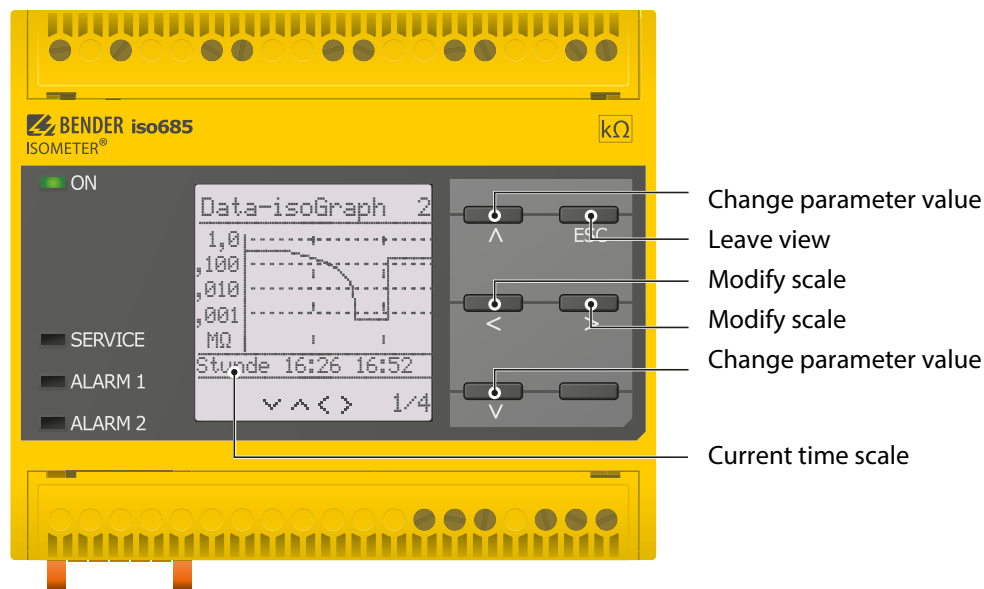

8.6 History memory

Up to 1023 alarm messages and device errors are stored in the history memory with date and time stamp. When the history memory is deleted, the minimum insulation resistance R_{min} will also be reset at Menu/Data Measured values - Data insulation.

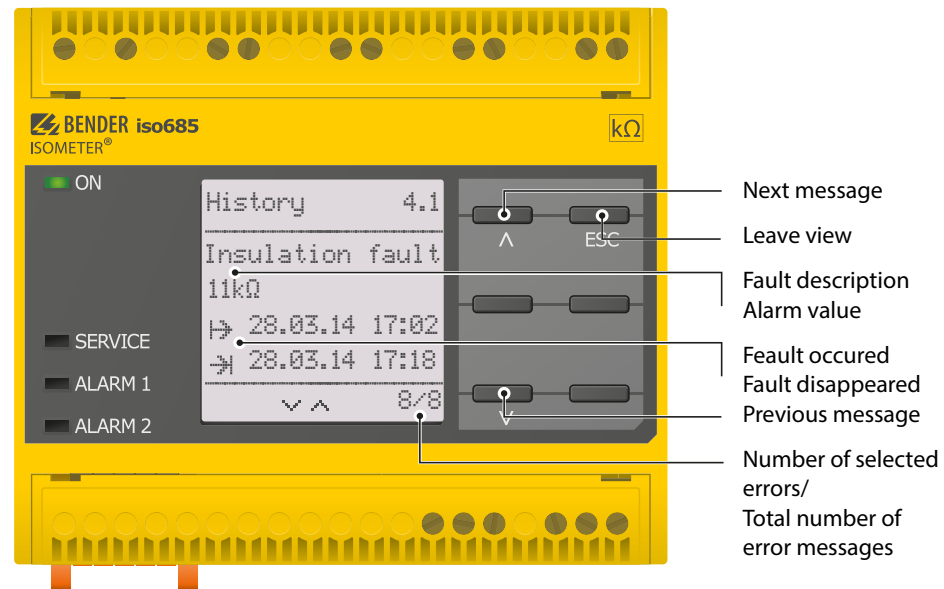

8.7 Initial measurement

During the initial measurement, the device records all measured values. All measured values that may have been recorded before will be discarded if a new initial measurement is started.

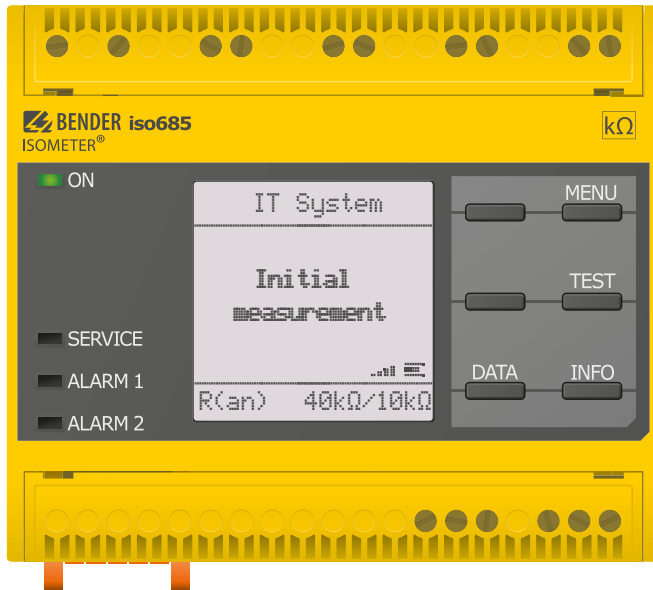

9.1 Menu structure

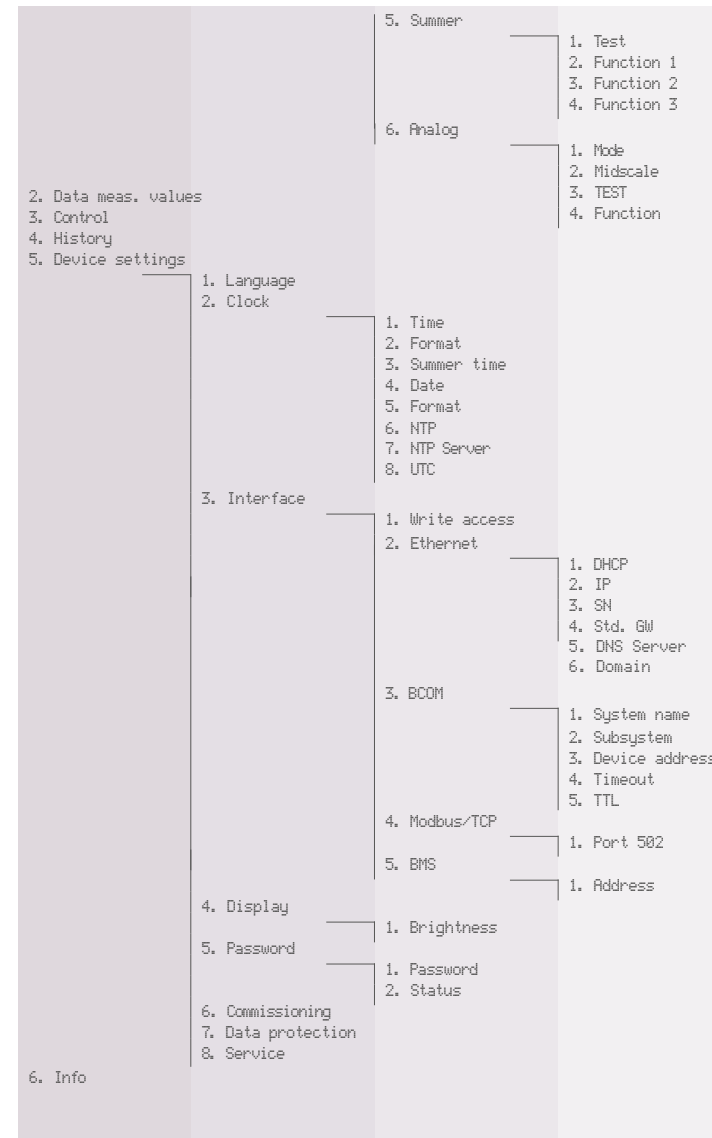
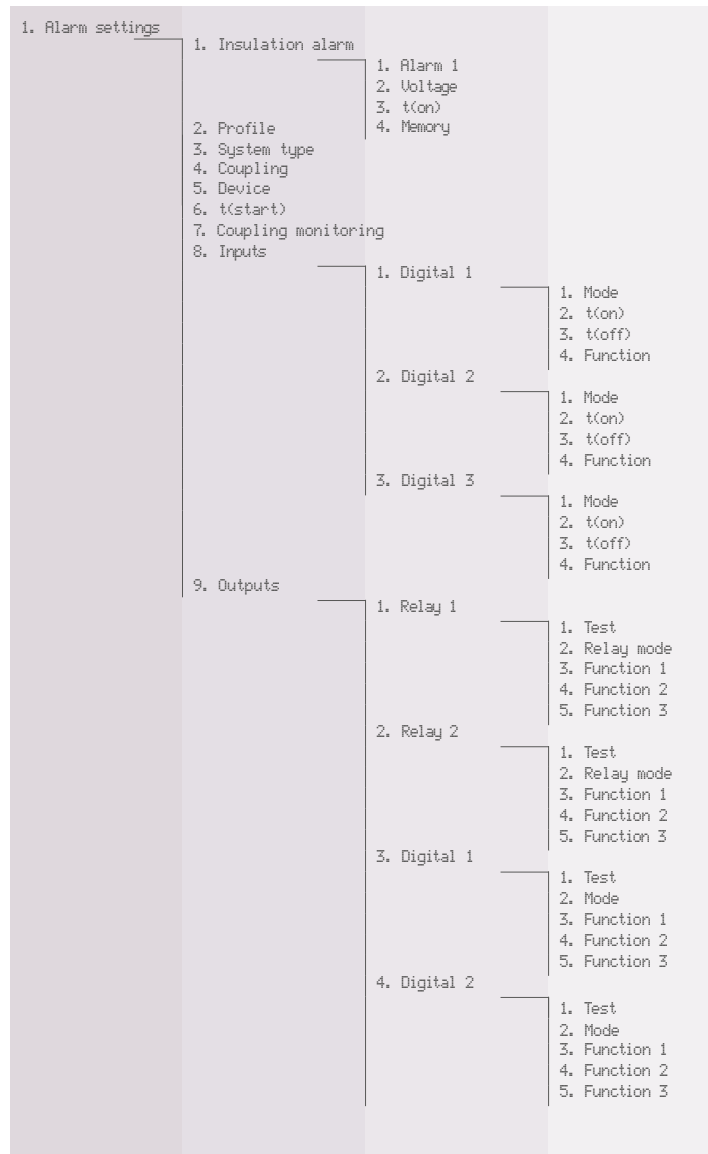

9.2 Operating and navigating

Navigate through the device menu using the device buttons. The functions of the device buttons are described in the chapter "Display elements and device buttons" on page 14.

9.2.1 Easy operation

Navigation in lists

To make a selection in a list, navigate using the ∇ and \blacktriangle buttons to the required menu item. Then click "OK".



Navigation with arrows

You can increase or decrease a value using the ∇ and \blacktriangle buttons. You can move to the left or the right to set different values using the \blacktriangleleft and \blacktriangleright buttons. The value positioned between the \blacktriangleleft and \blacktriangleright symbols is the value that is set.

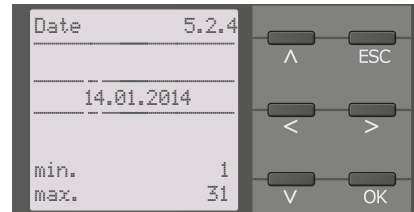

Text input

Go step by step through the numbers and letters indicated on the display by using the ∇ button (forwards) and the \blacktriangle button (backwards). Navigate to the right using the \blacktriangleright button to enter the next character. To delete a character that has been entered, use the \blacktriangleleft and \blacktriangleright buttons to navigate to the character to be deleted and then select "del" using the ∇ and \blacktriangle buttons. Confirm the entered text with "OK".



10.1 Settings in the device menu

The settings of the ISOMETER® are explained in the order of the device menu.

10.1 (1.0) Alarm settings

The limit values for the insulation resistances of alarm 1 and alarm 2 can be specified in the alarm settings menu and can be adapted to the user profile of the ISOMETER®. A device password is required for entering the settings. You can adjust the following functions:

10.1 (1.1) Insulation alarm

In the Insulation alarm menu, the ISOMETER® limit values for alarm 1 and alarm 2 can be set.

The activation or deactivation of the alarm for R_{an} is illustrated in the following graph:

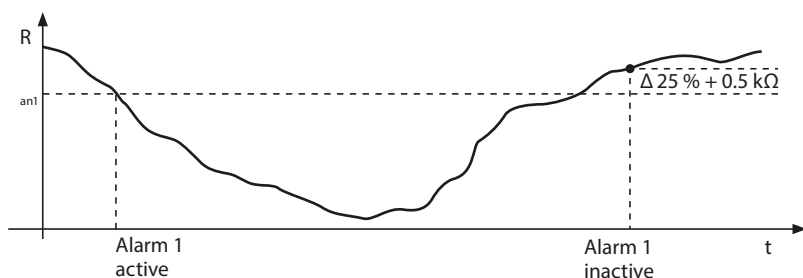

An alarm will become inactive as soon as +25 % +0.5 kΩ of the set operating value is exceeded.

10.1 (1.1.1) Alarm 1

For Alarm 1, an insulation resistance of between 1 kΩ...10 MΩ can be set.

10.1 (1.1.2) Voltage

The voltage can be set to a value within the range 20 V...1 kV.



The DC offset voltage and therefore the instantaneous tripping is only correct in a 60 Hz IT system. Other mains frequencies may cause incorrect readings and false alarms.

10.1 (1.1.3) t(on)

The reaction time t(on) after switch on can be set between 0...10 seconds.

10.1 (1.1.4) Fault memory

The fault memory can not be deactivated. If a fault becomes inactive, the programmed outputs remain in a fault condition until they are manually reset.

- *on If a fault becomes inactive, the programmed outputs remain in fault condition until they are reset manually.

10.1 (1.2) Profile

Adapt the area of application of the ISOMETER® to your system profile. For a description of the profiles, refer to [“Device profiles” on page 42](#).

The following can be selected:

- *Power circuits Especially suitable for the ISOMETER® isoNAV685-D with a frequency of 60 Hz
- *Inverter > 10 Hz Suitable for systems with dynamic frequency control by inverters in the range 10 to 460 Hz.
- *Inverter < 10 Hz Suitable for systems with extremely low frequency control in the range 1...460 Hz.

10.1 (1.3) System type

Especially for the ISOMETER® isoNAV685-D, the network configuration for the IT system to be monitored is set to 3AC.

- *3AC 3AC system
(refer to [“Connection to a 3\(N\)AC system” on page 18](#))

10.1 (1.4) Coupling

The ISOMETER® can not be operated with coupling devices.

- *None

10.1 (1.5) Device

Set the ISOMETER® insulation resistance measurement function to active or inactive:

- *Active The device is active.
- *Inactive The device DOES NOT measure the insulation resistance, the message `Device inactive` appears on the display. The IT system is NOT being monitored!

10.1 (1.6) T(Start)

The ISOMETER® can be operated with a start-up delay of 0...120 seconds. The start-up is delayed until the initial measurement takes place.

10.1 (1.7) Coupling monitoring

The ISOMETER® carries out coupling monitoring of L1-L2-L3 only after the device has been restarted or during manual tests. This monitoring can be disabled.

- *on Coupling monitoring is activated.
- *off Coupling monitoring of L1-L2-L3 is turned off.

10.1 (1.8) Inputs

The ISOMETER® provides a total of three digital inputs. The exemplary wiring diagram shows how the digital inputs can be wired:

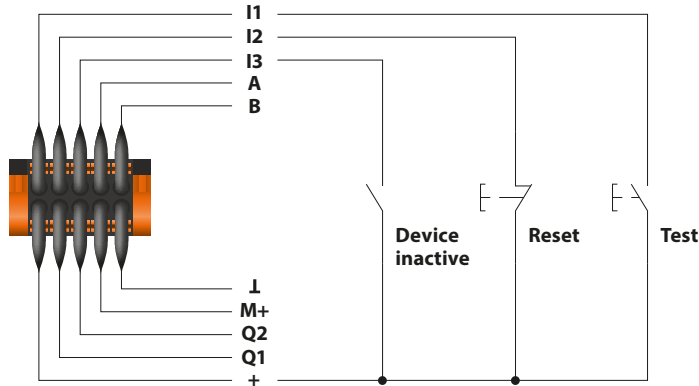

10.1 (1.8.1) Digital 1

The following parameters can be set for the digital input:

10.1 (1.8.1.1) Mode

The operating mode for the digital input can be set to the following values:

- *Active high An event is carried out on the rising edge of the digital input (low to high). Response time $t(on)/t(off)$ after a switch-on signal.

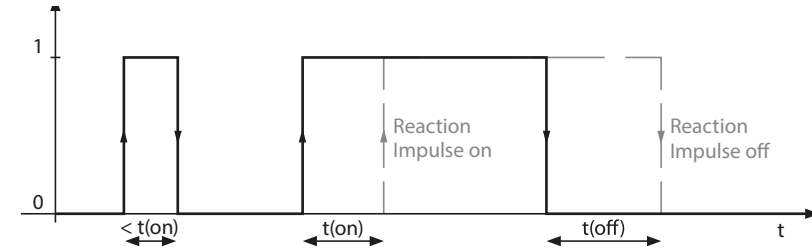
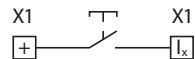

- *Active low An event is carried out on the falling edge of the digital input (high to low). Response time $t(on)/t(off)$ after a switch-off signal.

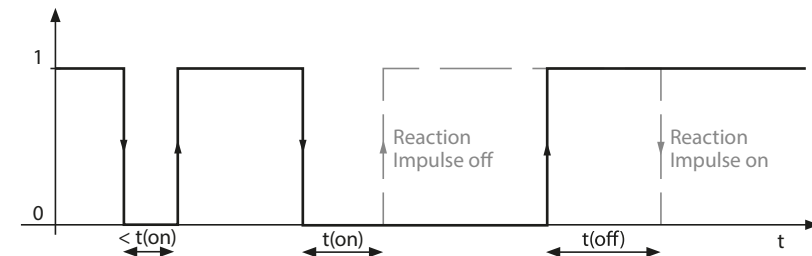

10.1 (1.8.1.2) $t(on)$

The response time $t(on)$ after a switch-on signal can be set between 100 milliseconds and 300 seconds (refer to "10.1 (1.8.1.1) Mode").

10.1 (1.8.1.3) $t(off)$

The response time $t(off)$ after a switch-off signal can be set between 100 milliseconds and 300 seconds (refer to "10.1 (1.8.1.1) Mode").

10.1 (1.8.1.4) Function

The parameters for the function of the digital inputs of the ISOMETER® can be set differently:

*off	Digital input without function
*TEST	Device self test
*RESET	Reset of fault and alarm messages
*Deactivate device	The device DOES NOT measure the insulation resistance, the message <code>Device inactive</code> appears on the display. The IT system is NOT being monitored!
*Start initial measurement	All recorded measurements are discarded and a new measurement is started

10.1 (1.8.2) Digital 2

Refer to "10.1 (1.8.1) Digital 1".

10.1 (1.8.3) Digital 3

Refer to "10.1 (1.8.1) Digital 1".

10.1 (1.9) Outputs

The ISOMETER® provides a total of six outputs.

The following parameters can be set for the outputs:

10.1 (1.9.1) Relay 1

The following parameters can be set for each relay:

10.1 (1.9.1.1) TEST

The functional test of the relay can be activated or deactivated. This only applies to the manual test and not to the cyclic device self test:

*on	The manual test checks the switching function of the relay
*off	The manual test does not check the switching function of the relay

10.1 (1.9.1.2) Relay mode

The relay mode can be adapted to the application:

*N/C	Normally closed- N/C operation contacts 11-12-14 / 21-22-24 (in fault-free condition, the alarm relay is energised).
*N/O	Normally opened - N/O operation contacts 11-12-14 / 21-22-24 (in fault-free condition, the alarm relay is de-energised).

10.1 (1.9.1.3) Function 1

Up to three functions can be assigned to one output. The functions are linked to an OR operator:

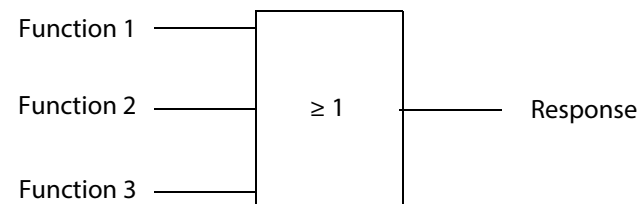

Select the appropriate setting for function 1. The following parameters can be set.

*off	The function is not used.
*Ins. Alarm 1	The status of the output changes when the value falls below the set response value R_{an1} .
*Insulation fault + DC shift error	The status of the output changes when the value falls below the set response value R_{an2} .
*Connection fault	The status of the output changes when one of the following connection fault occurs: <ul style="list-style-type: none"> • No low-resistance connection between the line conductors. • No low-resistance connection between the terminals E and KE to earth (PE). • The load connected to the current output is too low • The load connected to the current output is too high. • Load on X1 too high.
*Device fault	The status of the output changes in the event of an internal device fault.
*Common alarm	The status of the output changes on the occurrence of any alarm and fault messages (Ins. alarm 1 & 2, DC- / DC+ alarm, symmetrical alarm, connection and device faults).
*Measurement complete	The status of the output changes at the end of the initial measurement.
*Device inactive	The status of the output changes when the device has been deactivated via a digital input or the control menu.

10.1 (1.9.1.4) Function 2

Refer to "10.1 (1.9.1.3) Function 1".

10.1 (1.9.1.5) Function 3

Refer to "10.1 (1.9.1.3) Function 1".

10.1 (1.9.2) Relay 2

Refer to "10.1 (1.9.1) Relay 1".

10.1 (1.9.3) Digital 1

The following parameters can be set for each of the digital outputs:

The functional test of the digital output can be activated or deactivated. This only applies to the manual test and not to the cyclic device self test:

- *on The manual test changes the status of the digital output.
- *off The manual test does not change the status of the digital output.

10.1 (1.9.3.1) Mode

The following settings can be used to set the operating mode for the digital output:

- *Active In the active mode +24 V will be internally applied across the output.

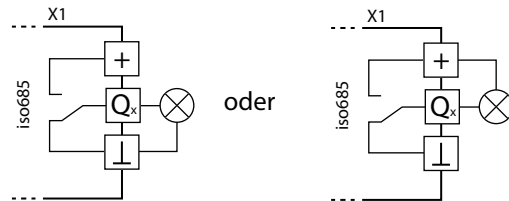

- *Passive In the passive mode ≤ 32 V are externally connected (see technical data). The output switches the applied potential to ground.

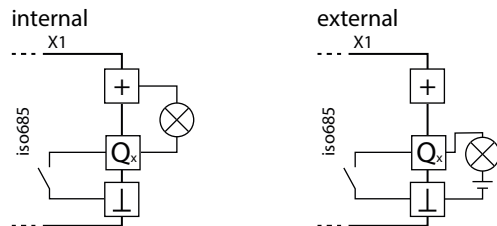

Observe the maximum output current!

Maximum output current in case of internal voltage supply via A1/+ and A2/-: 200 mA in total to X1.

Also refer to the formula for calculating I_{LmaxX1} in the Technical Data under "Digital Outputs (Q1, Q2)" on page 48.

10.1 (1.9.3.2) Function 1

Refer to "10.1 (1.9.1.3) Function 1".

10.1 (1.9.3.3) Function 2

Refer to "10.1 (1.9.1.3) Function 1".

10.1 (1.9.3.4) Function 3

Refer to "10.1 (1.9.1.3) Function 1".

10.1 (1.9.4) Digital 2

Refer to "10.1 (1.9.3) Digital 1".

10.1 (1.9.5) Buzzer

The following parameters can be set for the buzzer:

10.1 (1.9.5.1) TEST

The functional test of the buzzer can be activated or deactivated. This only applies to the manual test and not to the cyclic device self test:

- *on The manual test activates the buzzer sound.
- *off The manual test does not activate the buzzer sound.

10.1 (1.9.5.2) Function 1

Refer to "10.1 (1.9.1.3) Function 1".

10.1 (1.9.5.3) Function 2

Refer to "10.1 (1.9.1.3) Function 1".

10.1 (1.9.5.4) Function 3

Refer to "10.1 (1.9.1.3) Function 1".

10.1 (1.9.6) Analogue

The following parameters can be set for the analogue output:

10.1 (1.9.6.1) Mode

The following values can be set for the operating mode of the analogue output

Current output

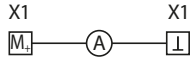

- *0-20 mA Permissible load ≤ 600 Ω
- *4-20 mA Permissible load ≤ 600 Ω
- *0-400 μA Permissible load ≤ 4 kΩ

Voltage output

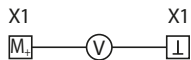

- *0-10 V Permissible load ≥ 1 kΩ
- *2-10 V Permissible load ≥ 1 kΩ

10.1 (1.9.6.2) Midscale

Select the appropriate midscale. The following parameters can be set:

- *Linear The switching signal is linear to the insulation resistance in the indicated measuring range.

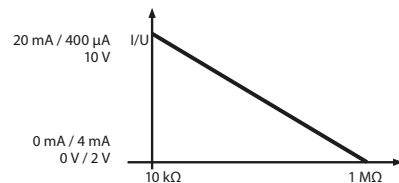

- *28 kΩ The switching signal is analogue to the mid scale of 28 kΩ or 120 kΩ on a measuring instrument.
- *120 kΩ

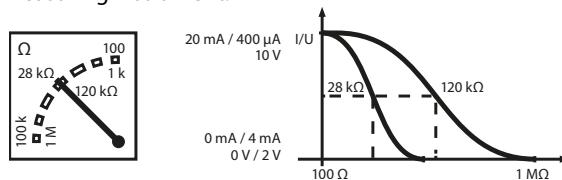

Calculation of the insulation resistance using the analogue output:

$$R_F = \frac{(A_2 - A_1) * R_{SKM}}{A_3 - A_1} - R_{SKM}$$

A₃ = Measured value analogue output

R_{SKM} = 28 kΩ or 120 kΩ/midscale

R_F = Insulation fault in kΩ

Lower value	Upper value
Analogue output A ₁	Analogue output A ₂
0 mA	20 mA
4 mA	20 mA
0 μA	400 μA
0 V	10 V
2 V	10 V

10.1 (1.9.6.3) TEST

The functional test of the analogue output can be activated or deactivated. In this way, the analogue output is adjusted once for the entire range. This only applies to the manual test and not to the cyclic device self test:

- *on The manual test checks the analogue output function.
- *off The manual test does not check the analogue output function.

10.1 (1.9.6.4) Function

Select the appropriate setting for the analogue output. The following parameters can be set.

- *Insulation value Depending on the measured insulation value, an analogue current or voltage signal is provided at the output.
- *DC offset Depending on the measured DC offset, an analogue current or voltage signal is provided at the output. This setting can only be used when Linear is selected in the menu "Midscale".

DC+ alarm	Symmetrical alarm	DC- alarm
0 %	25 %	100 %
0 V/2 V		10 V
0 mA/4 mA		20 mA
0 μA		400 μA

10.1 (2.0) Data measured values

The ISOMETER® stores certain measured values for a specific period of time. You can view these data at the "Data meas. values" menu point. Navigate through the different views using the \wedge and \vee buttons:

- *isoGraph data Displays the insulation resistance and chronological sequence.
See "Device communication" on page 38.
- *Insulation data Displays the current insulation resistance, the minimum insulation resistance measured and the system leakage capacitance.
- *IT system data Displays the system phase-to-phase voltages and the mains frequency (r.m.s. values)
- *IT system data Displays the system phase-to-earth voltages

10.1 (3.0) Control

In the control menu, you can start a manual test reset, reset alarm messages and start an initial measurement:

- *TEST Manual device test
- *RESET Reset of fault and alarm messages
- *Start initial measurement All recorded measurements are discarded and a new measurement is started

10.1 (4.0) History

In the history menu, the faults detected by the ISOMETER® are displayed. For a detailed functional description, refer to "History memory" on page 25.

- *History Overview of faults that have occurred
- *Delete Reset the history memory

10.1 (5.0) Device settings

The device settings menu allows you to configure the basic settings for the ISOMETER®.

10.1 (5.1) Language

Choose the language to be displayed by the ISOMETER®. For example, you can set the languages:

- *German
- *English
- *...

10.1 (5.2) Clock

In the clock menu you can set the display format of time and date for the ISOMETER®:

10.1 (5.2.1) Time

Based on the selected time format you can set the current time to display 24-hour or 12-hour notation (am/pm).

10.1 (5.2.2) Format (time)

Select the appropriate time format to be displayed:

- *12 h 12-hour notation am/pm
- *24 h 24-hour notation

10.1 (5.2.3) Summer time

Summer time can be considered in the following settings:

*off	No automatic change between summer time and standard time.
*DST	Daylight Saving Time Automatic change between summer and standard time according to North American regulation. North American summer time begins on each second Sunday in March at 02:00 local time by setting the clock forward by one hour from 2:00 to 03:00 local time. Summer time always ends the first Sunday in October at 03:00 local time by setting the clock back one hour from 3:00 to 2:00.
*CEST	Central European Summer Time Automatic change between summer time and standard time according to Central European regulation. Central European summer time begins on each last Sunday in March at 02:00 CEST by setting the clock forward by one hour from 2:00 to 03:00. Central European summer time always ends on the last Sunday in October at 03:00 CEST by setting the clock back one hour from 3:00 to 2:00.



When set to DST or CEST, changing between summer time and normal time is only done on the date of the official time change.

10.1 (5.2.4) Date

Based on the selected date format you can set the current date.

10.1 (5.2.5) Format (date)

Select the appropriate date format you want to be displayed:

*dd.mm.yy	day, month, year
*mm-dd-yy	month, day, year

10.1 (5.2.6) NTP

Select if you would like to synchronise the current time via NTP. You have to configure the NTP server in order to use this function (see [“NTP server” on page 35](#)).

*on	Synchronisation via NTP server is activated.
*off	Synchronisation via NTP server is deactivated.

10.1 (5.2.7) NTP server

Set the IP address of the NTP server.

10.1 (5.2.8) UTC

Set the time according to UTC (coordinated world time). For Germany, set +1 for winter-time (MEZ) and +2 for summer time (MESZ).

10.1 (5.3) Interface

Set the parameters for the connection of other devices to the ISOMETER® in the interface menu:

10.1 (5.3.1) Write access

Set whether the device can be parameterised externally via Modbus or web server. Displaying and reading out data via Modbus and web server is always possible, regardless of this setting.

*Allow	Allow external parameter setting.
*Deny	Refuse external parameter setting.

10.1 (5.3.2) Ethernet

Set the parameters for communication with other devices via the Ethernet interface. The Ethernet interface can be used for communication with Modbus, web server and BCOM.

10.1 (5.3.2.1) DHCP

Select whether you want to use automatic address assignment via your DHCP server. When the automatic IP address assignment is activated, the IP address, subnet mask and the standard gateway are assigned automatically. When the automatic IP address assignment is deactivated, you have to make these settings manually in the menu. The IP address can be viewed in the [“Info” menu \(see “Info” on page 37\)](#).

*on	Activate automatic IP address assignment.
*off	Deactivate automatic IP address assignment.

10.1 (5.3.2.2) IP

Set the appropriate IP address for the ISOMETER®.

10.1 (5.3.2.3) SN

Set the appropriate subnet mask.

10.1 (5.3.2.4) Std. GW

If a standard gateway is used, enter the IP address here.

10.1 (5.3.2.5) DNS server

If a DNS server is used, enter the server's IP address.

Contact your network administrator in case you have questions about the configuration of the DNS server.

10.1 (5.3.2.6) Domain

Enter the domain.

Contact your network administrator in case you have questions about the configuration of the domain.

10.1 (5.3.3) BCOM

Set the parameters for communication with other devices via BCOM.

For further information, refer to ["BCOM" on page 38](#).

10.1 (5.3.3.1) System name

Set the system name of the network in which the devices are located. In order to guarantee that all devices are able to communicate via BCOM, all devices must have the same system name.

10.1 (5.3.3.2) Subsystem

Configure the subsystem address of the network in which the devices are located. The devices can communicate with subsystems with the same or different subsystem addresses.

10.1 (5.3.3.3) Device address

Assign a device address. Each device must have a different address to distinguish it from another in the system and ensure correct communication.

10.1 (5.3.3.4) Timeout

Set the timeout for messages between 100 ms...10 s.

This time specification defines the maximum permissible time for a device to respond.

10.1 (5.3.3.5) TTL for subscription

Set a time between 1 s...1092 min.

This time defines the intervals at which the ISOMETER® sends messages to e.g. a gateway. Severe alarms (e.g. insulation alarms or substantial value changes) are always sent immediately.

10.1 (5.3.4) Modbus TCP

Settings for communication with other devices via Modbus TCP.

For further information, refer to ["Modbus TCP" on page 38](#).

10.1 (5.3.4.1) Port 502

Choose whether Modbus TCP should be used:

- *on Modbus TCP can be used for communication with other devices.
- *off Modbus TCP cannot be used for communication with other devices.

10.1 (5.3.5) BMS

The function of the BMS bus is not available in this device.

10.1 (5.4) Display

Adjust the display brightness for the ISOMETER® in the display menu:

10.1 (5.4.1) Brightness

Adjust the display brightness between 0 % and 100 % in steps of 10.

If no button is pressed on the display for 15 minutes, the brightness of the display is reduced. If now a button is pressed, the normal brightness is restored.

10.1 (5.5) Password

Use the password function to protect the device parameters against unauthorised adjustment. The default password is 0000.

10.1 (5.5.1) Password

Enter an individual four-digit password.

10.1 (5.5.2) Status

Decide if the password query should be used:

- *on Password query active
- *off Password query inactive

10.1 (5.6) Commissioning

In the commissioning menu you can open the ISOMETER®'s commissioning wizard again.

10.1 (5.7) Data backup

In the data backup menu device settings can be saved or device settings already saved can be restored.

- *Save The ISOMETER® saves your device settings.
- *Restore The ISOMETER® restores your initial device settings.

10.1 (5.8) Service

The service menu can only be accessed by Bender Service staff.

10.1 (6.0) Info

The ISOMETER®'s current settings can be viewed in the Info menu. Navigate through the different views using the \wedge and \vee buttons:

- *Device Device name, serial number, article number
- *Software Software version measurement technique, software version HMI
- *Measurement
-technique Selected profile, selected system type
- *Clock Time, date, summer time
- *Ethernet IP address, DHCP status, MAC address

11.1 Ethernet interface

The Ethernet interface can be used for communication with Modbus, web server and BCOM.

11.2 BCOM

BCOM is intended for communication between Bender devices via Ethernet.

All devices that communicate via BCOM must have the same system name. Devices can be organised in subsystems. Each device requires an individual device address.

For more information regarding BCOM, refer to the BCOM manual (D00256)

at <http://www.bender.de/manuals>.



When address 0 has been set for communication via BCOM the device can be accessed via the network (e.g. for parameter setting, etc.) but it cannot communicate with other devices.

11.3 Modbus TCP

Modbus is an international widely used protocol for data transfer between devices.

All measured values, messages and parameters are stored in virtual register addresses. Data can be read out with a read command on the register address. With a write command, data can be written into a register address.

The register addresses of the individual measured values und parameters can be found in the manual "iso685-D Annex A" with the title "ISOMETER® iso685 device family - Modbus settings" at <http://www.bender.de/manuals>.



A maximum of 5 TCP/IP connections can be used simultaneously.



In order to be able to parameterise the device externally via Modbus, the menu item "Allow" must have been set in the "Write access" menu (see "Write access" on page 35).

11.4 Web server

The ISOMETER® has an integrated web server which displays ISOMETER® data comfortably on every PC via a web browser. The web server can be used to read out measured values and parameterise the ISOMETER®s. You can access the web server by entering the IP address of the ISOMETER® into the browser (e.g. http://192.168.0.5). The Info menu provides information about the ISOMETER®s IP address (see 10.1 (6.0) "Info" on page 37).

The web server offers the following functions:

- Visualisation
 - Indication of device information (e.g. device type, software version, etc.)
 - Indication of current device settings.
 - Indication of alarm messages.
 - Indication of the Modbus information of the individual parameters.
 - Indication of the interfaces in use.
 - Overview of the current measured values.
 - Detailed graphic representation of the insulation resistance (isoGraph).
 - Fast and simple visualisation without any programming.
- Parameter setting
 - Easy and fast parameter setting of the device.
 - Easy assignment and edition options of device and measuring channel texts.
- Maintenance
 - Data storage of specific events for fast support by Bender Service.

A maximum of 5 TCP/IP connections can be used simultaneously.

Only one device may access the web server at the same time. If several devices try to access the web server it may result in timeouts.

The write access is deactivated by default in the device menu (= Deny). To be able to set parameters via the web server the write access must first be activated in the device menu (= Allow) (see "Write access" on page 35).

Use the web server preferably with the following web browsers: Google Chrome, Mozilla Firefox or Internet Explorer.

Web server device menu (first level)

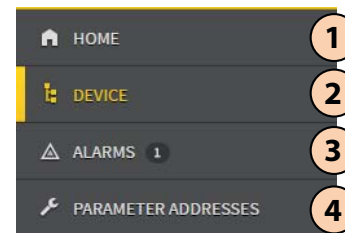

Legend for web server device menu (first level)

1	START	Indication of general device information.
2	DEVICE	Indication of an overview of alarm values and measured values. Indication of the settings. Settings can be changed here.
3	ALARMS	Indication of alarm messages.
4	PARAMETER ADDRESSES	Activate and deactivate the indication of the Modbus information by selecting or deselecting the selection box for the question "Display additional Modbus information for each parameter?".

Web server user interface

BENDER iso685W-D₂ ISOMETER
SYSTEM-240-15
8/15/16 4:26 PM

iso685W-D ADDR. 15 ✓

- Overview
- Menu
- Alarm settings
 - Insulation alarm
 - DC alarm
- Inputs
- Outputs
- Data meas. values
 - isoGraph
 - Data meas. values
- Control
- Settings
 - Clock
- Interface
- File
- Info

System OK ▲

iso685W-D Alarm/meas.values

#	Alarm	Test	Channel description	Measured value	
1	✓	--	R Insulation fault	520 kΩ	i
2	✓	--	R Insulation fault	520 kΩ	i
3	✓	--	Ce Capacitance	8 μF	i
4	✓	--	U(1-2) Voltage	--	i
5	✓	--	U(3-1) Voltage	145 V	i
6	✓	--	U(2-3) Voltage	--	i
7	✓	--	U(1-E) Voltage	< 10 V	i
8	✓	--	U(2-E) Voltage	--	i
9	✓	--	U(3-E) Voltage	144 V	i
10	✓	--	f Frequency	49.98 Hz	i
13	✓	--	Device error	0	i
14	✓	--	Device inactive	0	i
16	✓	--	Meas. quality	100 %	
17	✓	--	R min. Insulation fault	520 kΩ	i
19	✓	--	DC- alarm	49.02 %	
20	✓	--	DC+ alarm	49.02 %	
24	✓	--	U(DC offset) DC offset voltage	< 10 V	

Legend for user interface

5		<p>Main menu of the web server (first level)</p> <ul style="list-style-type: none"> • START (1) • DEVICE (2) • ALARMS (3) • PARAMETER ADDRESSES (4) <p>Refer to "Web server device menu (first level)" on page 39.</p>
6	Menu	Adjust device settings here.
7	Info	<ul style="list-style-type: none"> • Indication of device information regarding software, measurement technique, Ethernet and BS bus address. • Indication of Modbus information for the individual parameters. To be able to see this information, the selection box at PARAMETER ADDRESSES (4) for the question "Display additional Modbus information for each parameter?" must be activated.
8	System OK/ alarms	<p>Indication of the system status "System OK" (green button) and "Alarms" (red button).</p> <p>If there are pending alarms, click on the red button or go to menu point "ALARMS" (3) to obtain further information.</p>
9	Alarm/ meas.val- ues	Overview of alarm values and measured values.
10	i symbol	Click on the "i" symbol on the right side to obtain further information regarding measured values.

12. Device profiles

Adjustment to different applications can be carried out very easily by selecting a device profile.

	Nominal system voltage	Mains frequency	System leakage capacitance	Measuring voltage	Description
Power circuits	AC 0...690 V/	15...460 Hz	0...150 μ F	\pm 50 V	Main circuits without dynamic frequency changes. The universal profile is suitable for all systems primarily with constant mains frequencies and extraneous DC voltages. When using inverters and dynamic frequency control, select Inverter > 10 Hz or Inverter < 10 Hz.
Inverter > 10 Hz	AC 0...690 V/ DC 0...1000 V	10...460 Hz	0...20 μ F	\pm 50 V	This profile is used for systems with dynamic frequency control by inverters in the range 10 to 460 Hz in order to optimise the measurement with respect to the measuring time and quality.
Inverter < 10 Hz	AC 0...690 V/ DC 0...1000 V	1...460 Hz	0...20 μ F	\pm 50 V	For systems involving extremely low-frequency control in the range of up to 1...460 Hz and very low and continuously changing extraneous DC voltages due to dynamic load conditions in an IT system, continuous insulation monitoring can be optimised using this profile.

response times see ["Diagrams" on page 43](#).



The DC offset voltage and therefore the instantaneous tripping is only correct in a 60 Hz IT system. Other mains frequencies may cause incorrect readings and false alarms.

13.1 Response time profile power circuits

Response time as a function of the response value (R_{an}) and system leakage capacitance (C_e) according to IEC 61557-8 ($U_n = AC\ 690\ V, f_n = 60\ Hz$)

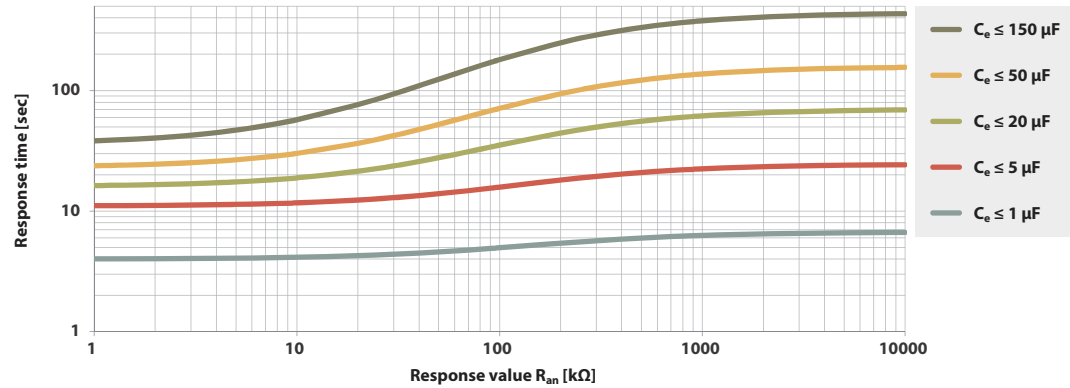

13.2 Response time profile inverter > 10 Hz

Response time as a function of the response value (R_{an}) and system leakage capacitance (C_e) according to IEC 61557-8 ($U_n = AC\ 690\ V, f_n = 60\ Hz$)

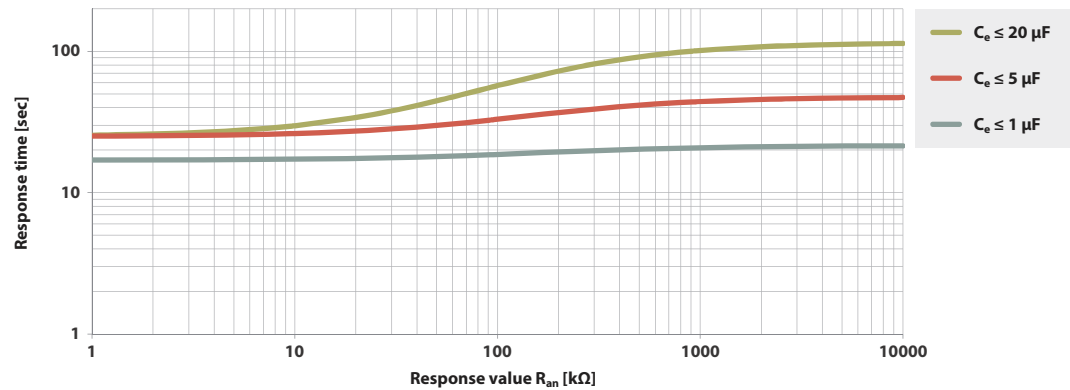

13.3 Response time profile inverter < 10 Hz

Response time as a function of the response value (R_{an}) and system leakage capacitance (C_e) according to IEC 61557-8 ($U_n = AC 690 V, f_n = 60 Hz$)

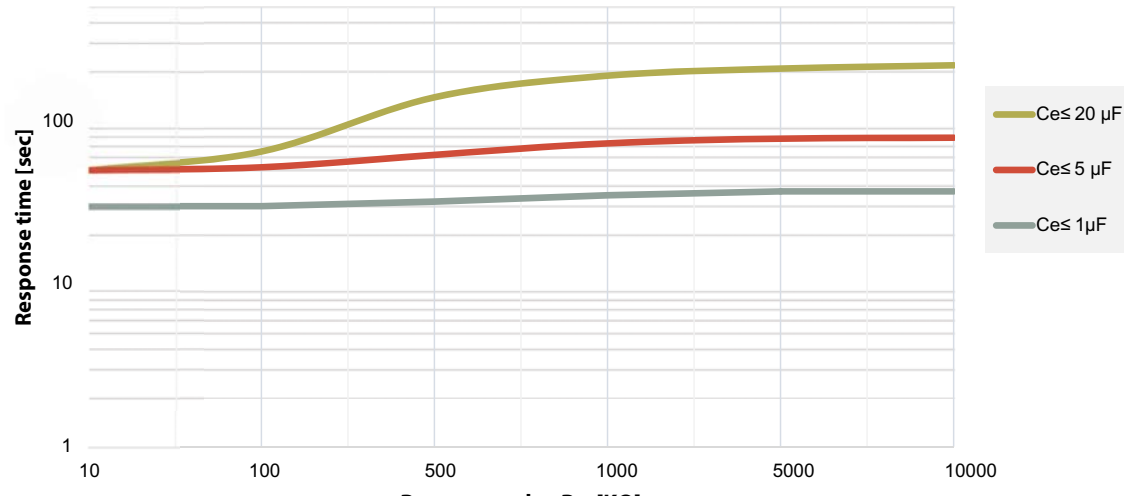

13.4 Relative uncertainty

Relative uncertainty as a function of the response value (R_{an}) and system leakage capacitance (C_e) according to IEC 61557-8 ($U_n = AC 690 V, f_n = 60 Hz$)

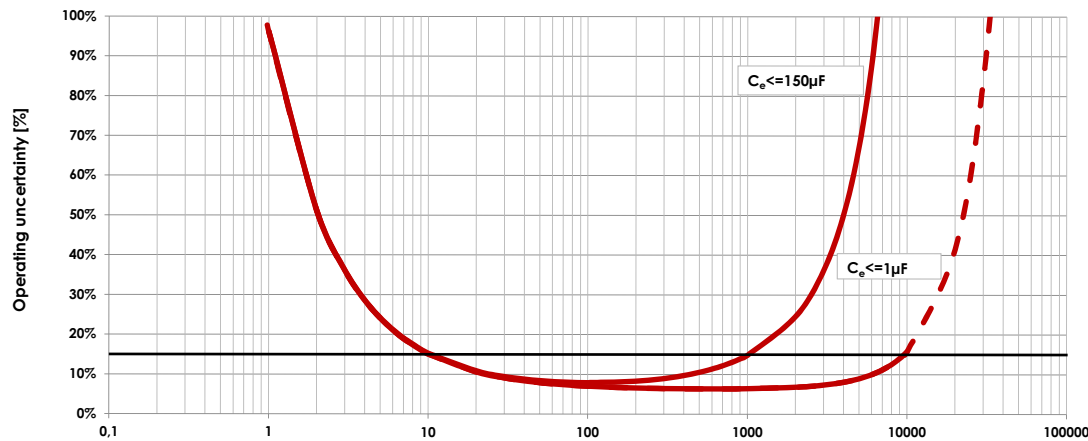

14. Alarm messages

Alarm message	Description	Measures	Reference	LED indicators
Insulation fault	An insulation fault exists. The insulation resistance falls below the response value R_{an1} .	<ul style="list-style-type: none"> Observe insulation resistance in the monitored system and, if necessary, eliminate fault. Reset fault message by pressing the reset button 	"Functional description" on page 10	ALARM 1 lights up
Insulation fault	An insulation fault exists. The insulation resistance falls below the response value R_{an2} and the DC offset voltage exceeds the response value.	<ul style="list-style-type: none"> Eliminate insulation fault in the system being monitored Reset fault message by pressing the reset button 	"Functional description" on page 10	ALARM 1 + ALARM 2 light up
Check L1-L2-L3 for correct connection!	No low-resistance connection between the line conductors	<ul style="list-style-type: none"> Check the wiring of terminals L1/+, L2 and L3/- to the IT system Press the test button Check mains voltage Check fuses Check set system type 	"Connection" on page 16 & menu setting "System type" on page 29	ALARM 1 + ALARM 2 flash alternately
Check E-KE connections for interruptions!	No low-resistance connection between terminals E and KE to earth (PE)	<ul style="list-style-type: none"> Check the wiring of terminals E and KE to earth (PE) Press the test button 	"Connection" on page 16	ALARM 1 + ALARM 2 flash in common mode
Service mode active!	The device is in maintenance condition	<ul style="list-style-type: none"> Contact Bender Service 		SERVICE lights up
The profile does not suit the application!	Wrong profile selected for this application	<ul style="list-style-type: none"> Check measured system capacitance or mains frequency in the Info menu Select another profile taking into consideration the characteristics 	"Device profiles" on page 42 & "Profile" on page 29	
No DHCP server found!	Connection problem at the Ethernet interface	<ul style="list-style-type: none"> Check cable connection at the Ethernet interface Check the DHCP server's availability Check the DHCP's interface configuration in the device 	"DHCP" on page 35	
Check time and date!	Time and date have not been set yet	<ul style="list-style-type: none"> Set local time and date (in case of voltage failure a buffer for three days) 	"Clock" on page 34	
Load on X1 too high!	Sum of the external loads on X1 is too high	<ul style="list-style-type: none"> Check load at X1.+, X1.Q1 and X1.Q2 Check ambient temperature 		
Device error x.xx	Internal device fault	<ul style="list-style-type: none"> Press the TEST button Switch the supply voltage off and on Contact Bender Service 		SERVICE lights up
Undervoltage	Operating outside the specified supply voltage range	<ul style="list-style-type: none"> Check supply voltage 		
Overvoltage	Operating outside the specified supply voltage range	<ul style="list-style-type: none"> Check supply voltage 		

Parameter	Value
Response values/alarms	
Response value R_{an1} (ALARM 1)	5 k Ω
Response value R_{an2} + DC offset voltage (ALARM 2)	150 V
Fault memory	off
Coupling monitoring	on
System	
System type	3AC
Profile	Power circuits
Coupling devices	
Coupling	none
Time response	
Start-up delay $T_{start-up}$	0 s
Digital inputs	
Digital input 1	
Mode (Operating mode)	Active high
Function	Deactivate device
Digital input 3	
Mode (Operating mode)	Active high
Function	Deactivate device
Digital outputs	
Digital output 1	
Function 1	Insulation fault + DC offset voltage

Parameter	Value
Switching elements	
Relay 1	
Operating mode	N/C operation
Function 1	Ins. alarm 1
Relay 2	
Operating mode	N/C operation
Function 1	Ins. alarm 2 + DC offset voltage
Interfaces	
DHCP	off
IP address	192.168.0.5
Net mask	255.255.255.0
BCOM address	system-1-0

16.1 Tabular data

Insulation coordination according to IEC 60664-1/IEC 60664-3

Definitions:

Measuring circuit (IC1).....	(L1/+, L2, L3/-)
Supply circuit (IC2).....	A1, A2
Output circuit 1 (IC3).....	11, 12, 14
Output circuit 2 (IC4).....	21, 22, 24
Control circuit (IC5).....	(E, KE), (X1, ETH, X3)
Rated voltage.....	1000 V
Overvoltage category.....	III
Rated impulse voltage:	
IC1 / (IC2-5).....	8 kV
IC2 / (IC3-5).....	4 kV
IC3 / (IC4-5).....	4 kV
IC4 / IC5.....	4 kV
Rated insulation voltage:	
IC1 / (IC2-5).....	1000 V
IC2 / (IC3-5).....	250 V
IC3 / (IC4-5).....	250 V
IC4 / IC5.....	250 V
Pollution degree for accessible parts on the outside of the device housing ($U_n < 690$ V).....	3
Pollution degree for accessible parts on the outside of the device housing ($U_n > 690 < 1000$ V).....	2
Protective separation (reinforced insulation) between:	
IC1 / (IC2-5).....	Overvoltage category III, 1000 V
IC2 / (IC3-5).....	Overvoltage category III, 300 V
IC3 / (IC4-5).....	Overvoltage category III, 300 V
IC4 / IC5.....	Overvoltage category III, 300 V
Voltage test (routine test) according to IEC 61010-1:	
IC2 / (IC3-5).....	AC 2,2 kV
IC3 / (IC4-5).....	AC 2,2 kV
IC4 / IC5.....	AC 2,2 kV

Supply voltage

Supply via A1/+, A2/-:	
Supply voltage range U_s	AC/DC 24...240 V
Tolerance of U_s	-30...+15 %
Maximum permissible input current of U_s	650 mA
Frequency range of U_s	DC, 50...400 Hz ¹⁾
Tolerance of the frequency range of U_s	-5...+15 %
Power consumption, typically 50/60 Hz.....	≤ 12 W/21 VA
Power consumption, typically 400 Hz.....	≤ 12 W/45 VA

Supply via X1:	
Supply voltage U_s	DC 24 V
Tolerance of U_s	DC -20...+25 %

IT system being monitored

Nominal system voltage range U_n	AC 0...690 V
.....	DC 0...1000 V
.....	AC/DC 0...600 V (for UL applications)
Tolerance of U_n	AC/DC +15 %
Frequency range of U_n	60 Hz

Response values

Response value R_{an1} (alarm 1).....	1 kΩ...10 MΩ
Response value DC residual voltage (Alarm 2) (U_{DC}).....	20 V...1 kV
Relative uncertainty (acc. to IEC 61557-8).....	profile dependent, ±15 %, at least ±1 kΩ
Hysteresis.....	25 %, at least 1 kΩ

Time response

Response time t_{an} for DC residual voltage $> 1,1xUDC$ and Alarm 1.....	max. 150 ms ²⁾
Response time t_{an} at $R_F = 0.5 \times R_{an}$ ($R_{an} = 10$ kΩ) and $C_e = 1$ μF acc. to IEC 61557-8.....	profile dependent, typ. 4 s (see diagrams)
Startup delay $T_{startup}$	0...120 s

Measuring circuit

Measuring voltage U_m	±50 V
Measuring current I_m	≤ 403 μA
Internal resistance R_i, Z_i	≥ 124 kΩ
Permissible extraneous DC voltage U_{fg}	≤ 1200 V
Permissible system leakage capacitance C_e	profile dependent, 0...150 μF

Measuring ranges

Measuring range f_n	10...460 Hz
Tolerance measurement of f_n	±1 % ±0.1 Hz
Voltage range measurement of f_n	AC 25...690 V
Measuring range U_n	AC 25...690 V
Voltage range measurement of U_n	AC/DC > 10 V
Tolerance measurement of U_n	±5 % ±5 V
Measuring range C_e	0...1000 μF
Tolerance measurement of C_e	±10 % ±10 μF
Min. insulation resistance measurement of C_e	depending on the profile and coupling mode, typ. > 10 kΩ

Display

Indication.....	graphic display 127 x 127 pixels, 40 x 40 mm ³⁾
Display range measured value.....	0.1 kΩ...20 MΩ

LEDs

ON (operation LED)	green
SERVICE	yellow
ALARM 1 (Iso. Alarm 1)	yellow
ALARM 2 (Insulation fault + DC offset fault)	yellow

In-/Outputs (X1-Interface)

Cable length X1 (unshielded cable).....	≤ 10 m
Cable length X1 (shielded cable, shield connected to earth (PE) on one end, recommended: J-Y(St)Y min. 2x0,8)	≤ 100 m
Total max. supply output current via X1.+/X1.GND for each output.....	max. 1 A
Total max. supply output current via A1/A2 on X1	max. 200 mA
Total max. supply output current via A1/A2 on X1 between 16,8 V and 40 V	
.....	$I_{LmaxX1} = 10mA + 7mA/V * U_s^{4)}$
.....	(negative values are not allowed for I_{LmaxX1})

Digital Inputs (I1, I2, I3)

Number	3
Operation mode, adjustable.....	active high, active low
Functions	none, test, reset, device deactivated, initial measurement
Voltage:.....	Low DC -3...5 V, High DC 11...32 V
Tolerance Voltage.....	± 10 %

Digital Outputs (Q1, Q2)

Number	2
Operating mode, adjustable.....	active, passive
Functions	none, insulation Alarm 1, insulation fault + DC residual voltage, connection fault, device fault, collective alarm, measurement ended, device inactive
Voltage.....	passive DC 0...32 V, active DC 0/19.2...32 V

Analogue Output (M+)

Number	1
Operating mode.....	linear, midscale point 28 kΩ/120 kΩ
Functions	insulation value, DC offset
Current	0...20 mA (< 600 Ω), 4...20 mA (< 600 Ω), 0...400 μA (< 4 kΩ)
Voltage.....	0...10 V (> 1 kΩ), 2...10 V (> 1 kΩ)
Tolerance	±20 %



Interfaces

Field bus:

Interface/protocol	web server/Modbus TCP/BCOM
Data rate	10/100 Mbit/s, autodetect
Max. amount Modbus requests	< 100/s
Cable length	≤ 100 m
Connection	RJ45
IP address.....	DHCP/manual 192.168.0.5
Network mask.....	255.255.255.0
BCOM address.....	system-1-0
Function	communication interface

Switching elements

Number of switching elements.....	2 changeover contacts
Operating mode.....	N/C operation/N/O operation
Contact 11-12-14	none, insulation Alarm 1, insulation fault + DC residual voltage, connection fault, device fault, collective alarm, measurement ended, device inactive
Contact 21-22-24	none, insulation Alarm 1, insulation fault + DC residual voltage, connection fault, device fault, collective alarm, measurement ended, device inactive
Electrical endurance under rated operating conditions, number of cycles.....	10.000
Contact data acc. to IEC 60947-5-1:	
Utilisation category.....	AC-13 / AC-14 / DC-12 / DC-12 / DC-12
Rated operational voltage	230 V / 230 V / 24 V / 110 V / 220 V
Rated operational current	5 A / 3 A / 1 A / 0.2 A / 0.1 A
Rated insulation voltage ≤ 2000 m NN	250 V
Rated insulation voltage ≤ 3000 m NN	160 V
Minimum contact rating	1 mA at AC/DC ≥ 10 V

Environment/EMC

EMC	IEC 61326-2-4 ⁵⁾
Ambient temperatures:	
Operating temperature.....	-25...+55 °C
Transport.....	-40...+85 °C
Long-term storage.....	-40...+70 °C
Classification of climatic conditions acc. to IEC 60721:	
Stationary use (IEC 60721-3-3)	3K5 (except condensation and formation of ice)
Transport (IEC 60721-3-2)	2K3
Long-term storage (IEC 60721-3-1).....	1K4
Classification of mechanical conditions acc. to IEC 60721:	
Stationary use (IEC 60721-3-3)	3M4
Transport (IEC 60721-3-2).....	2M2
Long-term storage (IEC 60721-3-1).....	1M3
Area of application.....	≤ 3000 m NN

Connection

Connection type.....pluggable screw-type terminal or push-wire terminal

Screw-type terminals:

Nominal current..... ≤ 10 A
 Tightening torque..... 0.5 . . . 0.6 Nm (5 . . . 7 lb-in)
 Conductor sizes.....AWG 24-12
 Stripping length..... 7 mm
 rigid/flexible 0.2 . . . 2.5 mm²
 flexible with ferrules, with/without plastic sleeve..... 0.25 . . . 2.5 mm²
 Multiple conductor, rigid..... 0.2 . . . 1 mm²
 Multiple conductor, flexible..... 0.2 . . . 1.5 mm²
 Multiple conductor, flexible with ferrule without plastic sleeve 0.25 . . . 1 mm²
 Multiple conductor, flexible with TWIN ferrule with plastic sleeve 0.5 . . . 1.5 mm²

Push-wire terminals:

Nominal current..... ≤ 10 A
 Conductor sizes.....AWG 24-12
 Stripping length..... 10 mm
 rigid/flexible 0.2 . . . 2.5 mm²
 flexible with ferrules, with/without plastic sleeve..... 0.25 . . . 2.5 mm²
 Multiple conductor, flexible with TWIN ferrule with plastic sleeve 0.5 . . . 1.5 mm²

Push-wire terminals X1:

Nominal current..... ≤ 8 A
 Conductor sizes.....AWG 24-16
 Stripping length..... 10 mm
 rigid/flexible 0.2 . . . 1.5 mm²
 flexible with ferrule without plastic sleeve..... 0.25 . . . 1.5 mm²
 flexible with TWIN ferrule with plastic sleeve 0.25 . . . 0.75 mm²

Other

Operating mode..... continuous operation
 Mounting (0°) display oriented, cooling slots must be ventilated vertically⁶⁾
 Degree of protection internal components IP40
 Degree of protection terminals IP20
 DIN rail mounting acc. to..... IEC 60715
 Screw fixing 3 x M4 with mounting clip
 Enclosure material..... polycarbonate
 Flammability class..... V-0
 ANSI code 64
 Dimensions (W x H x D) 108 x 93 x 110 mm
 Weight..... < 390 g

- 1) At a frequency > 200 Hz, the connection of X1 must be insulated. Only permanently installed devices which at least have over-voltage category CAT2 (300V) may be connected.
- 2) Fast tripping only works in IT networks with a mains frequency of 60 Hz.
- 3) Indication limited outside the temperature range -25 . . . +55 °C.
- 4) U_s [Volt] = supply voltage ISOMETER®
- 5) This is a class A product. In a domestic environment, this product may cause radio interference. In this case, the user may be required to take corrective actions.
- 6) Recommendation: Devices mounted at 0° (display-oriented, cooling slots must be ventilated vertically).
 For devices mounted at an angle of 45°, the max. working temperature is reduced by 10 °C.
 For devices mounted at an angle of 90°, the max. working temperature is reduced by 20 °C.

16.2 Standards and certifications

The ISOMETER® has been developed in compliance with the following standards:

- DIN EN 61557-8 (VDE 0413-8):2015-12
- IEC 61557-8:2014-12
- IEC 61557-8:2014/COR1:2016
- DIN EN 61557-8 Ber 1 (VDE 0413-8 Ber 1):2016-12

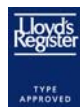

16.3 Ordering details

Type	Supply voltage U_S	Art. No.
isoNAV685-D	AC 24...240 V; 50...400 Hz	B91067014

Accessories

Description	Art. No.
iso685 Mechanical accessories comprising: Terminal cover and 2 mounting clips*	B91067903
iso685 Plug kit, screw terminals*	B91067901
iso685 plug kit, with push-wire terminals	B91067902

* included in the scope of delivery

Suitable system components

Description	Type	Art. No.
Suitable measuring instruments	7204-1421	B986763
SKMP** : 28 kΩ, 120 kΩ Current values: 0...400 μA, 0...20 mA (additonal information here)	9604-1421	B986764
	9620-1421	B986 841

** SKMP = midscale point

- BCOM Protocol for communication between Bender devices via an IP-based network.
- DHCP Dynamic Host Configuration Protocol. It is used to assign the network configuration to Clients via a server.
- Modbus TCP Modbus is an international widely spread protocol for data transfer.
- System (BCOM) The system is the entire installation that is visible for the customer and defined by the customer. The BCOM communication takes place within this system. Naturally, different systems can exist independently in one network.
- Subsystem (BCOM) The subsystem structures parts of the system as units defined by the customer, e.g. all PQ devices. A typical subsystem are also "non BCOM-capable" devices that are hidden behind a proxy.
- Web server A web server presents the device functions graphically. The web server can be used for reading out measured values and for parameter setting.

18.1 General information

This appendix provides a complete description of the Modbus register (protocol version 6.0) for the ISOMETER® iso685 family of devices to facilitate access to information.

The adjustable parameters for individual keys are listed.

In general, the Registers are implemented as Modbus read-only register (RO = read only). An exception is the DO control register, which only has a write function (WO = write only). The ISOMETER® iso685 device family supports 4-digit addressing and the following Modbus functions:

4. Holding registers for reading values
(Read Holding Register; function code 0x03)
5. Registers for device programming
(Preset Multiple Registers; function code 0x10)

For the complete Modbus protocol specification, visit <http://www.modbus.org>.

18.2 Data access by means of Modbus/TCP-Protokoll

Requests to the iso685 Modbus/TCP-Server are carried out using the Function code FC4 (read input registers). The server generates a function-related response and sends it to the Modbus client.



Maximum of Modbus TCP requests per second: 100/s.

18.2.1 Exception code

If a request cannot be answered for whatever reason, the server sends a so-called exception code to limit possible errors.

Exception-Code	Description
0x01	Invalid function
0x02	Invalid data access
0x03	Invalid data value
0x04	Slave device error
0x05	Acceptance confirmed (response is delayed)
0x06	Request not accepted (repeat request if necessary)
0x08	Memory: Parity error
0x0A	Gateway path not available
0x0B	Gateway Error

18.2.2 Modbus request

By means of the function code FC3, the required information, in Words, can be read from the ISOMETER® iso685 input registers. To enable this, the start address and the number of registers to be read must be specified.

Example:

The insulation value should be read from the input register with a start address of 0x2000.

Byte	Name	Example
Byte 0,1	Transaction identifier	0x0000
Byte 2,3	Protocol identifier	0x0000
Byte 4,5	Length field	0x0006
Byte 6	Unit identifier	BCOM device address
Byte 7	Modbus function code	0x03
Byte 8,9	Register address defined in "Modbus register assignment" on page 55	0x2000
Byte 10,11	Number of Words	0x0002

18.2.3 Modbus response

The response consists of 2 bytes per register. The byte sequence is defined with the Most Significant Bit (MSB) first.

Byte	Name	Example
...
Byte 7	Modbus function code	0x03
Byte 8	Byte count	0x04
Byte 9,10	Value in Register 0	0x1234 (fictitious value)
Byte 11,12	Value in Register 1	0x2345 (fictitious value)

18.2.4 Structure of exception code

Byte	Name	Example
...
Byte 7	Modbus function code	0x83
Byte 8	Exception code	0x01 or 0x02

18.3 Measuring value information

18.3.1 High-byte test status

Value	Description
0	No test
1	Internal test
2	External test

18.3.2 Low-byte alarm status

Value	Description
0	No alarm
1	Pre-warning
2	Fault
3	Reserved
4	Warning
5	Alarm

18.3.3 High-byte range

Value	Description
0	=
1	<
2	>
3	Invalid

18.3.4 Low-byte unit

Value	Description
0	Invalid
1	None
2	Ohm
3	Ampere
4	Volt

5	Percent
6	Hertz
7	Baud
8	Farad
9	Henry
10	Degree Celsius
11	Degree Fahrenheit
12	Second
13	Minute
14	Hour
15	Day
16	Month
17	Watt
18	var
19	VA
20	Wh
21	varh
22	Vah
23	Degree
24	Hertz per second

18.4 Modbus register assignment

Register address (hexadecimal)	Register address (decimal)	Description	Number	Data type	Mode	Comment	Range	Unit
Device information								
0x510	1296	Device model	32	String UTF 8	RO			
0x520	1312	Article number	32	String UTF 8	RO			
0x530	1328	Serial number	32	String UTF 8	RO			
0x540	1344	Manufacturer	96	String UTF 8	RO			
0x570	1392	D-number Interface	2	Uint16	RO	Software number of the interface unit		
0x571	1393	Software-Version interface	2	Uint16	RO			
0x578	1400	D-number measuring technique	2	Uint16	RO	Software number of the measuring technique		
0x579	1401	Software version measuring technique	2	Uint16	RO			
Measuring values								
0x1010	4112	Channel number (1)	number	Uint16	RO			
0x1011	4113	Insulation value	4	Float	RO	Insulation value		Ω
0x1013	4115	Test and alarm status	2	Uint16	RO	High-byte test, Low-byte alarm status (see page 53)		
0x1014	4116	Range and unit	2	Uint16	RO	High-byte range, Low-byte unit (see page 53)		
0x1015 - 0x1018	4117 - 4120	Internal use			RO	Must be read. Values are only relevant for internal use.		
0x1019 - 0x101F	4121-4127	0	2	Uint16	RO			

Register address (hexadecimal)	Register address (decimal)	Description	Number	Data type	Mode	Comment	Range	Unit
0x1020	4128	Channel number (2)	2	Uint16	RO			
0x1021	4129	Insulation value	4	Float	RO	Insulation value		Ω
0x1022 - 0x102F	4131-4143	See previous channel			RO			
0x1030	4144	Channel number (3)	2	Uint16	RO			
0x1031	4145	Leakage capacitance	4	Float	RO			F
0x1033 - 0x103F	4147-4159	See previous channel			RO			
0x1040	4160	Channel number (4)	2	Uint16	RO			
0x1041	4161	Voltage L1-L2	4	Float	RO	Voltage measured between phase L1 and phase L2		V
0x1043 - 0x104F	4163-4175	See previous channel			RO			
0x1050	4176	Channel number (5)	2	Uint16	RO			
0x1051	4177	Voltage L1-L3	4	Float	RO	Voltage measured between phase L1 and phase L3		V
0x1053 - 0x105F	4179-4191	See previous channel			RO			
0x1060	4192	Channel number (6)	2	Uint16	RO			
0x1061	4193	Voltage L2-L3	4	Float	RO	Voltage measured between phase L2 and phase L3		V
0x1063 - 0x106F	4195-4207	See previous channel			RO			
0x1070	4208	Channel number (7)	2	Uint16	RO			
0x1071	4209	Voltage L1-PE	4	Float	RO	Voltage measured between phase L1 and PE		V
0x1073 - 0x107F	4211-4223	See previous channel			RO			
0x1080	4224	Channel number (8)	2	Uint16	RO			
0x1081	4225	Voltage L2-PE	4	Float	RO	Voltage measured between phase L2 and PE		
0x1083 - 0x108F	4227-4239	See previous channel			RO			
0x1090	4240	Channel number (9)	2	Uint16	RO			
0x1091	4241	Voltage L3-PE	4	Float	RO	Voltage measured between phase L3 and PE		
0x1093 - 0x109F	4243-4255	See previous channel			RO			

Register address (hexadecimal)	Register address (decimal)	Description	Number	Data type	Mode	Comment	Range	Unit
0x10A0	4256	Channel number (10)	2	Uint16	RO			
0x10A1	4257	DC residual voltage	4	Float	RO			V
0x10A3 - 0x10AF	4259-4271	See previous channel			RO			
0x10B0	4272	Channel number (11)	2	Uint16	RO			
0x10B1	4273	Power frequency	4	Float	RO			
0x10B3 - 0x10BF	4275-4287	See previous channel			RO			
0x10C0	4288	Channel number (12)	2	Uint16	RO			
0x10C1	4289	System connection	4	Float	RO	0 = O.K. 101 = error		
0x10C3 - 0x10CF	4291-4303	See previous channel			RO			
0x10D0	4304	Channel number (13)	2	Uint16	RO			
0x10D1	4305	Connection to earth	4	Float	RO	0 = O.K. 101 = error		
0x10D3 - 0x10DF	4307-4319	See previous channel			RO			
0x10E0	4320	Channel number (14)	2	Uint16	RO			
0x10E1	4321	Device error	4	Float	RO	Device error number (e.g. 750 -> 7.50 Communication CAN)		
0x10E3 - 0x10EF	4323-4335	See previous channel			RO			
0x10F0	4336	Channel number (15)	2	Uint16	RO			
0x10F1	4337	DC Offset	4	Float	RO	DC shift in the system 0 % = Fault on DC+ 100 % = Fault on DC-		
0x10F3 - 0x10FF	4339-4351	See previous channel			RO			
0x1100	4352	Channel number (16)	2	Uint16	RO			
0x1101	4353	Quality of the measurement	4	Float	RO	Quality of measuring value 0 % = Poor quality => change profile 100 % = Good quality => Profile fits to the application		
0x1103 - 0x110F	4355-4367	See previous channel			RO			
0x1110	4368	Channel number (17)	2	Uint16	RO			

Register address (hexadecimal)	Register address (decimal)	Description	Number	Data type	Mode	Comment	Range	Unit
0x1111	4369	Minimum insulation value	4	Float	RO	Minimum insulation value measured		Ω
0x1113 - 0x111F	4371-4383	See previous channel			RO			
0x1120	4384	Channel number (18)	2	Uint16	RO			
0x1121	4385	Symmetric alarm	4	Float	RO	DC fault shift in percent 0%-25% -> Fault on DC+ 25%-75% -> Symmetrical fault 75%-100% -> Fault on DC-	0...100	%
0x1123 - 0x112F	4387-4399	See previous channel			RO			
0x1130	4400	Channel number (19)	2	Uint16	RO			
0x1131	4401	DC minus alarm	4	Float	RO	See 0x1121		
0x1133 - 0x113F	4403-4415	See previous channel			RO			
0x1140	4416	Channel number (20)	2	Uint16	RO			
0x1141	4417	DC plus alarm	4	Float	RO	See 0x1121		
0x1143 - 0x114F	4419-4431	See previous channel			RO			

Register address (hexadecimal)	Register address (decimal)	Description	Number	Data type	Mode	Comment	Range	Unit
//ReadOnly								
0x2000u	8192	Insulation vaue	4	Float	RO			Ω
0x2002u	8194	Minimum Insulation value	4	Float	RO	Minimum measured value		Ω
0x2004u	8196	Insulation capacitance	4	Float	RO			F
0x2006u	8198	Voltage L1-L2	4	Float	RO	Voltage measured between phase L1 and phase L2		V
0x2008u	8200	Voltage L1-L3	4	Float	RO	Voltage measured between phase L1 and phase L3		V
0x200Au	8202	Voltage L2-L3	4	Float	RO	Voltage measured between phase L2 and phase L3		V
0x200C	8204	Voltage L1-PE	4	Float	RO	Voltage measured between L1 and PE		V
0x200E	8206	Voltage L2-PE	4	Float	RO	Voltage measured between L2 and PE		V
0x2010	8208	Voltage L3-PE	4	Float	RO	Voltage measured between L3 and PE		V
0x2012	8210	System frequency	4	Float	RO			Hz
0x2014	8212	System connection	4	Float	RO	101 = Error; 0 = OK		
0x2016	8214	Connection to earth	4	Float	RO	101 = Error; 0 = OK		
0x2018	8216	Device error	4	Float	RO	Device error number (e.g. 750 -> 7.50 Communication CAN)		
0x201C	8220	DC Offset	4	Float	RO	DC shift in the system 0 % = Fault on DC+ 100 % = Fault on DC-		%
0x201E	8222	Quality of measured value	4	Float	RO	Quality of measuring value 0 % = Poor quality => change profile 100 % = Good quality => Profile fits the application		%
0x2026	8230	Duration of measuring pulse	4	Float	RO	0 % = Measuring pulse has switched 100 % = Measuring pulse just before switching		

Register address (hexadecimal)	Register address (decimal)	Description	Number	Data type	Mode	Comment	Range	Unit
0x2FFEu	12286	Actual IP Address	4	UInt32	RO	Currently used IP address aaa.bbb.ccc.ddd => $aaa \cdot 256^3 + bbb \cdot 256^2 + ccc \cdot 256 + ddd$		
//IP-Configuration								
0x3000u	12288	DHCP on/off	2	UInt16	R/W	1 = DHCP on 2 = DHCP off	1...2	
0x3001u	12289	IP Address	4	UInt32	R/W	Configured IP address (used when DHCP = off) aaa.bbb.ccc.ddd => $aaa \cdot 256^3 + bbb \cdot 256^2 + ccc \cdot 256 + ddd$	0... 4.294.967.295	
0x3003u	12291	Standard Gateway	4	UInt32	R/W	Configured gateway (used when DHCP = off) aaa.bbb.ccc.ddd => $aaa \cdot 256^3 + bbb \cdot 256^2 + ccc \cdot 256 + ddd$	0... 4.294.967.295	
0x3005u	12293	Subnet mask	2	UInt16	R/W	Configured subnet mask (used when DHCP = off) Number of leading "1" s in the binary subnet mask e.g. 6 => 111111 00.00000000.00000000 0.00000000 = 252.0.0.0	1...32	

Register address (hexadecimal)	Register address (decimal)	Description	Number	Data type	Mode	Comment	Range	Unit
//ModbusTCP Mode								
0x3006u	12294	Modbus TCP on/off	2	Uint16	R/W	1 = Port 502 (ModbusTCP) on 2 = Port 502 (ModbusTCP) off	1...2	
0x3007u	12295	Writing to registers on/off	2	Uint16	R/W	1 = Writing parameters on 2 = Writing parameters off	1...2	
//BCOM								
0x300Au	12298	BCOM system name	16	String UTF 8	R/W	BCOM system name	A-Z0-9_	
0x3012u	12306	BCOM subsystem address	2	Uint16	R/W	BCOM device address	1...255	
0x3013u	12307	Device address	4	Float	R/W		1...255	
0x3014u	12308	Message timeout	4	Float	R/W	BCOM message timeout	0.1...10	s
0x3016u	12310	Repeat interval	2	Uint16	R/W	Time interval in which a BCOM messages is sent from a device to the Gateway at the latest	0...65.535	s
0x3019u	12313	DNS server IP	4	Uint32	R/W	IP address of the DNS server aaa.bbb.ccc.ddd => $aaa*256^3 + bbb*256^2 + ccc*256 + ddd$	0... 4.294.967.295	
0x301Bu	12315	DNS domain	250	String UTF 8	R/W	DNS domain	a-z0-9\.\-	
//Time								
0x3098u	12440	Time	4	Unix Time	R/W			
0x309Au	12442	0	4	0	R			
0x309Cu	12444	Time zone	4	Float	R/W	Time zone offset	-12...13	h
0x309Eu	12446	NTP on/off	2	Uint16	R/W	1 = NTP on 0 = NTP Off	1...2	
0x309Fu	12447	NTP server IP	4	Uint32	R/W	IP address of the NTP server aaa.bbb.ccc.ddd => $aaa*256^3 + bbb*256^2 + ccc*256 + ddd$	0... 4.294.967.295	
0x30A1u	12449	Date format	2	Uint16	R/W	1 = d.m.y 2 = m.d.y	1...2	

Register address (hexadecimal)	Register address (decimal)	Description	Number	Data type	Mode	Comment	Range	Unit
0x30A2u	12450	Summertime	2	Uint16	R/W	1 = off 2 = DST 3 = CEST	1...3	
0x30A3u	12451	Time format	2	Uint16	R/W	1 = 12 h 2 = 24 h	1...2	
//BMS								
0x30A4u	12452	BMS address	2	Uint16	R/W	BMS address	1...90	
//DigitalInFunctions								
0x30A5u	12453	Digital Input 1 Function	2	Uint16	R/W	1 = Off 2 = Test 3 = Reset 4 = Deactivate device 5 = Start initial measuring	1...5	
0x30A6u	12454	Digital Input 1 Mode	2	Uint16	R/W	1 = active high 2 = active low	1...2	
0x30A7u	12455	Digital Input 1 T(on)	4	Float	R/W	ON delay because of debounce	0.1...300	s
0x30A9u	12457	Digital Input 1 T(off)	4	Float	R/W	OFF delay because of debounce	0.1...300	s
0x30ABu	12459	Digital Input 2 Function	2	Uint16	R/W	see 0x30A5u - 0x30A9u	1...5	
0x30ACu	12460	Digital Input 2 Mode	2	Uint16	R/W	see 0x30A5u - 0x30A9u	1...2	
0x30ADu	12461	Digital Input 2 T(on)	4	Float	R/W	see 0x30A5u - 0x30A9u	0.1...300	s
0x30AFu	12463	Digital Input 2 T(off)	4	Float	R/W	see 0x30A5u - 0x30A9u	0.1...300	s
0x30B1u	12465	Digital Input 3 Function	2	Uint16	R/W	see 0x30A5u - 0x30A9u	1...5	
0x30B2u	12466	Digital Input 3 Mode	2	Uint16	R/W	see 0x30A5u - 0x30A9u	1...2	

Register address (hexadecimal)	Register address (decimal)	Description	Number	Data type	Mode	Comment	Range	Unit
0x30B3u	12467	Digital Input 3 T(on)	4	Float	R/W	see 0x30A5u - 0x30A9u	0.1...300	s
0x30B5u	12469	Digital Input 3 T(off)	4	Float	R/W	see 0x30A5u - 0x30A9u	0.1...300	s
//DigitalOutFunctions								
0x30B7u	12471	Digital Output 1 Function 1	2	Uint16	R/W	1 = off 2 = Insulation alarm 1 3 = Insulation alarm + DC offset fault 4 = Connection fault 5 = Device error 6 = Common alarm 7 = Measuring finished 8 = Device inactive	1...8	
0x30B8u	12472	Digital Output 1 Function 2	2	Uint16	R/W	see 0x30B7u	1...8	
0x30B9u	12473	Digital Output 1 Function 3	2	Uint16	R/W	see 0x30B7u	1...8	
0x30BAu	12474	Digital Output 1 Mode	2	Uint16	R/W	1 = Passive 2 = Active	1...2	
0x30BBu	12475	Digital Output 1 Test	2	Uint16	R/W	1 = Test on 2 = Test off	1...2	
0x30BCu	12476	Digital Output 2 Function 1	2	Uint16	R/W	see 0x30B7u - 0x30BBu	1...8	
0x30BDu	12477	Digital Output 2 Function 2	2	Uint16	R/W	see 0x30B7u - 0x30BBu	1...8	
0x30BEu	12478	Digital Output 2 Function 3	2	Uint16	R/W	see 0x30B7u - 0x30BBu	1...8	
0x30BFu	12479	Digital Output 2 Mode	2	Uint16	R/W	see 0x30B7u - 0x30BBu	1...2	
0x30C0u	12480	Digital Output 2 Test	2	Uint16	R/W	see 0x30B7u - 0x30BBu	1...2	

Register address (hexadecimal)	Register address (decimal)	Description	Num- ber	Data type	Mode	Comment	Range	Unit
//AnalogOutFunctions								
0x30C1u	12481	Analogue Output Function	2	Uint16	R/W	1 = Insulation value 2 = DC shift	1...2	
0x30C2u	12482	Analogue Output Mode	2	Uint16	R/W	1 = 0...20 mA 2 = 4...20 mA 3 = 0... 400 µA 4 = 0...10 V 5 = 2...10 V	1...5	
0x30C3u	12483	Analogue Output Midscale	2	Uint16	R/W	1 = Linear 2 = 28 kΩ 3 = 120 kΩ	1...3	
0x30C4u	12484	Analogue Output Test	2	Uint16	R/W	1 = Test on 2 = Test off	1...2	
//BuzzerFunctions								
0x30C5u	12485	Summer Function 1	2	Uint16	R/W	see 0x30B7u	1...11	
0x30C6u	12486	Summer Function 2	2	Uint16	R/W	see 0x30B7u	1...11	
0x30C7u	12487	Summer Function 3	2	Uint16	R/W	see 0x30B7u	1...11	
0x30C8u	12488	Summer Test	2	Uint16	R/W	1 = Test on 2 = Test off	1...2	
//RelayOutFunctions								
0x30C9u	12489	Relay 1 Test	2	Uint16	R/W	1 = Test on 2 = Test off	1...2	
0x30CAu	12490	Relay 1 Mode	2	Uint16	R/W	1 = N/O 2 = N/C	1...2	
0x30CBu	12491	Relay 1 Function 1	2	Uint16	R/W	see 0x30B7u	1...11	
0x30CCu	12492	Relay 1 Function 2	2	Uint16	R/W	see 0x30B7u	1...11	
0x30CDu	12493	Relay 1 Function 3	2	Uint16	R/W	see 0x30B7u	1...11	

Register address (hexadecimal)	Register address (decimal)	Description	Number	Data type	Mode	Comment	Range	Unit
0x30CEu	12494	Relay 2 Test	2	Uint16	R/W	1 = Test on 2 = Test off	1...2	
0x30CFu	12495	Relay 2 Mode	2	Uint16	R/W	1 = N/O 2 = N/C	1...2	
0x30D0u	12496	Relay 2 Function 1	2	Uint16	R/W	see 0x30B7u	1...11	
0x30D1u	12497	Relay 2 Function 2	2	Uint16	R/W	see 0x30B7u	1...11	
0x30D2u	12498	Relay 2 Function 3	2	Uint16	R/W	see 0x30B7u	1...11	
//InsulationAlarm								
0x30D3u	12499	Response value 1	4	Uint32	R/W		1,000... 10,000,000	Ω
0x30D5u	12501	Response value 2	4	Uint32	R/W		1,000... 10,000,000	Ω
0x30D7u	12503	Type of mains supply system	2	Uint16	R/W	1 = 3AC	1	
0x30D8u	12504	Profiles	2	Uint16	R/W	1 = Power circuits 2 = Inverter >10Hz 3 = Inverter < 10Hz	1...3	
0x30D9u	12505	Coupling monitoring	2	Uint16	R/W	1 = Coupling monitoring on 2 = Coupling monitoring off	1...2	
0x30DAu	12506	Coupling devices	2	Uint16	R/W	1 = No coupling device	1	
0x30DBu	12507	Fault memory	2	Uint16	R/W	1 = Fault memory on	1	
0x30DCu	12508	Start-up delay	2	Uint16	R/W		0...120	s
0x30DDu	12509	Activate/deactivate device	2	Uint16	R/W	1 = Activates device 2 = Deactivates device	1...2	
0x30DE	12510	DC Alarm	2	Uint16	R/W		20...1,000	V
0x30DF	12511	DC Alarm on/off	2	Uint16	R/W	1 = DC Alarm on 2 = DC Alarm off	1...2	

A

Accessories 50

Alarm

Alarm settings 29

Reset alarm message 34

B

BCOM 38, 51

Button

DATA 14

ESC 14

Info 14

MENU 14

OK 14

RESET 14

TEST 14

Buttons 14

C

Characteristic curves 43

Commissioning 21

Commissioning wizard 21

Initial commissioning 21

Recommissioning 22

Communication interfaces 38

Connection

3(N)AC system 18

Connection conditions 16

Connections and panel 13

Ethernet interface 19

Relay 1 interface (11 12 14) 20

Relay 2 interface (21 22 24) 20

Supply voltage 19

X1 interface 18

Coupling device 43

Coupling monitoring 30

D

Data - isoGraph 38

Date 35

Setting the date 34

Device buttons 14

DHCP 35, 51

Diagrams 43

Display 14, 22

Data - isoGraph 38

Fault display (active) 23

Fault display (inactive) 23

Fault memory 24

History memory 25

Limit values for R(an) 22

Signal quality of the measurement 22

Standard display 22

E

Ethernet interface 19

F

Features 10

Functional description

iso685-D 10

H

Hazards when handling the device 8

History memory 25

I

Initial measurement 26, 34

Inputs 30

Installation

DIN rail mounting 16

- Screw mounting 15
- Insulation resistance
 - Activate/deactivate measurement 29
- Intended use 9
- Interfaces 11, 35
 - BCOM 36, 38
 - Ethernet 35, 38
 - Modbus TCP 36
 - Modbus/TCP 38
 - Web server 39
 - X1 18

L

- Language 34
- LEDs
 - ALARM 1 14
 - ALARM 2 14
 - ON 14
 - SERVICE 14

M

- Mains frequency 42
- Mains voltage 9
- Measured values 34
- Menu 27
- Minimum current rectifier 17
- Minimum distance 16
- Modbus settings 52
- Modbus TCP 51
- Modbus/TCP 38

N

- Nominal system voltage 42, 47
- Nominal voltage 16
- Normal operation 22

O

- Operating mode 30
- Operation
 - Buttons 21
 - Commissioning 17, 21
- Ordering information 50
- Output 31

P

- Password 36
- Product description 10
- Profile overview 42
- Protective earth conductor (PE) 16

R

- Response time
 - Profile inverter 10 Hz 44
 - Profile power circuits 43
 - Relative uncertainty 44
- Response value 47

S

- Safety instructions 8
- Self test 11, 22
- Service menu 37
- Set language 34
- Setting the time 34, 35
- Settings 42
 - Alarm 29
 - Basic settings 34
 - Coupling devices 29, 43
 - Coupling monitoring 30
 - Inputs 30
 - Language 34
 - Manual test 34

Measured values 34
Profile 29
Sicherheitshinweise 55
Signal quality of the measurement 22
Start-up delay 29
System leakage capacitance 9, 10, 42

T

Technical data 47

W

Web server 39, 51



Bender GmbH & Co. KG

Postbox 1161 • 35301 Gruenberg • Germany
Londorfer Straße 65 • 35305 Gruenberg • Germany

Tel.: +49 6401 807-0
Fax: +49 6401 807-259

E-Mail: info@bender.de
Web: www.bender.de

Customer service

Service hotline: 0700-BenderHelp (Telephone and Fax)
Carl-Benz-Straße 8 • 35305 Gruenberg • Germany

Tel.: +49 6401 807-760
Fax: +49 6401 807-629

E-Mail: info@bender-service.com
Web: <http://www.bender.de>



BENDER Group