



VMD460-NA

Network and system protection (NS protection) for monitoring the power feed-in of power generation systems

Software version: D398 V1.4x

Display software version: D403 V2.4x





Bender GmbH & Co. KG

Postfach 1161 • 35301 Grünberg • Germany
Londorfer Str. 65 • 35305 Grünberg • Germany
Tel.: +49 6401 807-0 • Fax: +49 6401 807-259
E-Mail: info@bender.de • www.bender.de

© Bender GmbH & Co. KG

All rights reserved.
Reprinting only with permission
of the publisher.
Subject to change!

Photos: Bender archive and Bendersystembau archive

Table of Contents

1. General instructions	7
1.1 How to use this manual	7
1.2 Technical support: service and support	7
1.3 Training courses	8
1.4 Delivery conditions, warranty and liability	9
1.5 Inspection, transport and storage	9
1.6 Warranty and liability	9
1.7 Disposal	10
2. Safety instructions	11
2.1 General safety instructions	11
2.2 Work activities on electrical installations	11
2.3 Device-specific instructions	12
2.4 Intended use	12
3. Functional description	13
3.1 Measurement functions	13
3.1.1 Monitoring of different system types: 1AC, 3AC, 3NAC	13
3.1.2 Continuous monitoring of the phase voltage and line-to-line voltage	13
3.2 Disconnection	14
3.3 (Re)connection and special reconnections	14
3.3.1 (Re)connection and monitoring of the conditions	14
3.3.2 Exceptions of automatic (re-)connection	14
3.3.3 Special reconnections	15
3.4 Protective and monitoring functions	15
3.4.1 Voltage protection functions $U<$, $U<<$, $U>>$ and $U>$	15
3.4.2 Frequency protection functions $f<$, $f<<$, $f>>$ and $f>$	16
3.4.3 Anti-islanding detection / loss of mains (LOM), df/dt (ROCOF), vector shift detection	17
3.4.4 Unbalance detection	19
3.4.5 Monitoring of the tripping circuits and interface switches by means of contact feedback	19
3.4.6 Remote trip: remote disconnection via ripple-control receiver	20
3.4.7 Test function for checking the tripping circuit, the interface switch and for determining the connection times	20
3.4.8 Automatic self test	20

3.5	Other functions	21
3.5.1	Password protection	21
3.5.2	Protection against unauthorised access - sealable enclosure	22
3.5.3	Reset device to factory settings	22
3.5.4	History memory of the last 300 faults with time stamp (real-time clock)	22
4.	Installation, connection and commissioning	23
4.1	Unpacking	23
4.2	Fuses	23
4.3	Installation instructions	24
4.4	Principle diagrams	24
4.5	Dimension diagram VMD460-NA	25
4.6	DIN rail mounting	25
4.7	Screw mounting	25
4.8	Wiring diagrams	26
4.8.1	VDE-AR-N 4105:2018 – basic program 4105_2	26
4.8.2	VDE-AR-N 4105:2018 – basic program 4105_2 with several generating units	28
4.8.3	VDE-AR-N 4110:2018-11 – basic program 4110	30
4.8.4	EREC G99, G98, C10/11, DIN V VDE V 0126-1-1 basic programs G98, G99, C10/11, 0126	32
4.8.5	CEI 0-21	34
4.8.6	Details regarding the digital inputs (D1...D4, RT1)	36
4.8.7	Further standards	37
4.9	Commissioning	39
4.10	Tripping circuit test by the system installer	39
5.	Operation and settings	40
5.1	User interface	40
5.2	Display indications	41
5.2.1	Standard display	41
5.2.2	Info display	41
5.2.3	Alarm display	41
5.2.4	Menu display	42
5.2.5	Toggling between the individual displays	42
5.3	INFO button	43
5.4	MENU button	43
5.4.1	Alarm/ meas. values	44
5.4.2	History	45
5.4.3	Settings	46
5.4.4	System	46
5.4.5	Info	48

6. Basic programs	49
6.1 VDE-AR-N 4105:2018-09	51
6.2 VDE-AR-N 4105:2011-08	53
6.3 VDE-AR-N 4110:2018-11	55
6.4 BDEW guideline 2008	57
6.5 DIN V VDE V 0126-1-1:2006-02/A1:2012-02	59
6.6 CEI 0-21(:2012-06, :V1:2012-12, :V2:2013-12, :2014-09, :V1:2014-12; 2016-07, V1:2017-07)	61
6.7 C10/11:2006-06	64
6.8 G98/1-4:2019	66
6.9 G59/3:2013, G83/2:2012	68
6.10 G99/1-4:2019	70
6.11 G59/2:2010, -1/2011	72
7. Maintenance, troubleshooting, messages	74
7.1 Recurrent test of the tripping circuit by the system operator	74
7.2 Manual self test	74
7.3 Messages and malfunctions	76
7.4 LEDs	77
8. Technical data VMD460-NA	78
8.1 Standards, approvals and certifications	81
8.2 Ordering details	81
8.3 Change log	82
INDEX	83

1. General instructions

1.1 How to use this manual



This manual is intended for **qualified personnel** working in electrical engineering and electronics!

We have used the following symbols to identify important instructions and information:



This signal word indicates that there is a **high risk of danger** that will result in **death** or **serious injury** if not avoided.



This signal word indicates a **medium risk** of danger that can lead to **death** or **serious injury**, if not avoided.



This signal word indicates a **low-level risk** that can result in **minor or moderate injury** or **damage to property** if not avoided.



This symbol denotes information intended to assist the user in making **optimum use** of the product.

1.2 Technical support: service and support

For commissioning and troubleshooting Bender offers:

First level support

Technical support by phone or e-mail for all Bender products

- Questions about specific customer applications
- Commissioning
- Troubleshooting

Telephone: +49 6401 807-760*

Fax: +49 6401 807:-259 Germany: 0700BenderHelp (telephone and fax) E-

mail: support@bender-service.de

Repair service

Repair, calibration, update and replacement service for all Bender products

- Repair, calibration, testing and analysis
- Hardware and software update
- Delivery of replacement devices for faulty or incorrectly delivered devices
- Extended warranty with in-house repair service or replacement device at no extra cost

Telephone: +49 6401 807-780** (technical issues)/
+49 6401 807-784**, -785** (commercial issues)

Fax: +49 6401 807-789

E-mail: repair@bender-service.de

Please send the devices for repair to the following address:

Bender GmbH, Repair-Service, Londerfer Straße 65, 35305 Grünberg

Field service

On-site service for all Bender products

- Commissioning, parameter setting, maintenance, troubleshooting
- Analysis of the electrical installation in the building (power quality test, EMC test, thermography)
- Practical training courses for customers

Telephone: +49 6401 807-752**, -762 ** (technical issues)/
+49 6401 807-753** (commercial issues)

Fax: +49 6401 807-759

E-mail: fieldservice@bender-service.de

Internet: www.bender.de

*Available from 7.00 a.m. to 8.00 p.m. on 365 days of the year (CET/UTC +1)

**Mo-Thu 7.00 a.m. - 4.00 p.m., Fr 7.00 a.m. - 1.00 p.m

1.3 Training courses

Bender provides training on how to use the universal measuring device.

Current dates of training courses and workshops can be found on the Internet at <http://www.bender.de> -> Know-how -> Seminars.

1.4 Delivery conditions, warranty and liability

The conditions of sale and delivery set out by Bender GmbH apply.

For software products, the "Softwareklausel zur Überlassung von Standard- Software als Teil von Lieferungen, Ergänzung und Änderung der Allgemeinen Lieferbedingungen für Erzeugnisse und Leistungen der Elektroindustrie" (software clause in respect of the licensing of standard software as part of deliveries, modifications and changes to general delivery conditions for products and services in the electrical industry) set out by the ZVEI (Zentralverband Elektrotechnik- und Elektronikindustrie e.V., (German Electrical and Electronic Manufacturers' Association) also applies.

Conditions of sale and delivery can be obtained from Bender in printed or electronic format.

1.5 Inspection, transport and storage

Inspect the dispatch and equipment packaging for damage, and compare the contents of the package with the delivery documents. In the event of damage in transit, please contact Bender immediately.

The devices must only be stored in areas where it is protected from dust, humidity and spray or dripping water, and in which the specified storage temperatures can be assured.

1.6 Warranty and liability

Warranty and liability claims in the event of injury to persons or damage to property are excluded if they can be attributed to one or more of the following causes:

- Improper use of the device.
- Incorrect mounting, commissioning, operation and maintenance of the device.
- Failure to observe the instructions in this operating manual regarding transport, commissioning, operation and maintenance of the device.
- Unauthorised changes to the device made by parties other than the manufacturer.
- Non-observance of technical data.
- Repairs carried out incorrectly and the use of replacement parts or accessories not approved by the manufacturer.
- Catastrophes caused by external influences and force majeure.
- Mounting and installation with device combinations not recommended by the manufacturer.

This operating manual, especially the safety instructions, must be observed by all personnel working on the device. Furthermore, the rules and regulations that apply for accident prevention at the place of use must be observed.

1.7 Disposal

Abide by the national regulations and laws governing the disposal of this device. Ask your supplier if you are not sure how to dispose of the old equipment.

The directive on waste electrical and electronic equipment (WEEE directive) and the directive on the restriction of certain hazardous substances in electrical and electronic equipment (RoHS directive) apply in the European Community. In Germany, these policies are implemented through the "Electrical and Electronic Equipment Act" (ElektroG). According to this, the following applies:

- Electric and electronic equipment are not to be included in household waste.
- Batteries and accumulators are not to be included in household waste but must be disposed of in accordance with the regulations.
- Old electrical and electronic equipment from users other than private households which was introduced to the market after 13th August 2005 must be taken back by the manufacturer and disposed of properly.

For more information on the disposal of Bender devices, refer to our website at www.bender.de -> Service & support.

2. Safety instructions

2.1 General safety instructions

Part of the device documentation in addition to this manual is the enclosed "Safety instructions for Bender products".



Read the operating manual **before** starting to install, connect and commission the device. After successful commissioning, keep the manual within easy reach for future reference.

2.2 Work activities on electrical installations



Only **qualified personnel** are permitted to carry out the work necessary to install, commission and run a device or system.



DANGER

Risk of fatal injury from electric shock

Touching live parts of the system carries the risk of:

- A fatal electric shock
- Damage to the electrical installation
- Destruction of the device

Before installing the device and before working on the connections of the device, make sure that the system is de-energised. The rules for working on electrical systems must be observed.

If the device is used outside the Federal Republic of Germany, the applicable local standards and regulations must be complied with.

2.3 Device-specific instructions



Unauthorised device access

*After commissioning, the essential settings of the VMD460-NA have to be protected against unauthorised changes by a password. **If the password protection is not used, the device has to be sealed.***

Inspection

If the device is overloaded by overvoltage or a short-circuit current load, it must be checked and replaced if necessary.

2.4 Intended use

The VMD460-NA voltage and frequency monitoring relay is used for network and system protection (NS protection) of CHP plants, wind power stations, hydroelectric power stations and photovoltaic systems feeding power into the network. If inadmissible voltage and frequency values occur on the supply side, the VMD460-NA disconnects the generating plant from the public network by means of the interface switch.

In order to meet the requirements of applicable standards, customised parameter settings must be made on the equipment in order to adapt it to local equipment and operating conditions. Please heed the limits of the area of application indicated in the technical specifications.

In the context of VDE-AR-N 4110:2018-11, the VMD460-NA can be used as decoupling protection equipment for the generating unit or as higher-level decoupling protection, the latter, however, only if the QU protection function (directional reactive power undervoltage protection) may be dispensed with. According to VDE-AR-N 4110:2018-11 chapter 10.3.3.4 par. 5, this is possible after consultation with the network operator and under the following conditions:

- Generating plants with limited dynamic network support or
- Generating plants < 1 MVA

Both types of application are possible when the generating plant is connected to the busbar of a substation (MV-busbar) or when the generating plant is connected to the medium-voltage network (MV-network).

Any other use than that described in this document is regarded as improper.

3. Functional description

The VMD460-NA is intended for protecting the network and the (generating) plant from inadmissible operating states and for causing a disconnection. For this purpose, the VMD460-NA is designed according to the principles of single-fault tolerance. This occurs as soon as at least one of the activated protective or monitoring functions trips. If the (re-)connection conditions are fulfilled, the VMD460-NA enables the coupling of the generating plant to the network.

Details are regulated by the applicable (application) standard and guideline.

- Which protective and monitoring functions are used or are active/inactive.
- How the protective and monitoring functions are parameterised in detail.
- Further details regarding calculation methods and device behaviour
- Whether the (re-)connection takes place automatically or after manual acknowledgement.

The country-specific (application) standards and guidelines are stored in the device as selectable basic programs.

3.1 Measurement functions

3.1.1 Monitoring of different system types: 1AC, 3AC, 3NAC

The VMD460-NA is able to monitor different system types (1AC, 3AC, 3NAC). The system type is defined via the "Coupling" parameter.

In addition, the nominal system voltage is set via the " $U_{(L-N)}/U_{(L-L)}$ " parameter.

3.1.2 Continuous monitoring of the phase voltage and line-to-line voltage

The VMD460-NA continuously measures the available phase voltages and line-to-line voltages as well as the power frequency. It also calculates the measured quantities relevant for the protective and monitoring functions.

3.2 Disconnection

As soon as at least one of the activated protective or monitoring functions has tripped, the VMD460-NA issues a disconnection command via contacts K1 and K2 to the connected interface switches. First K1 and then K2 are tripped with a delay of 50 ms.



Special disconnection behaviour VDE-AR-N 4105:2018-11 and CEI 0-21

Contrary to the above behaviour, K1 is tripped and K2 remains energised instead. A disconnection signal is only output via relay K2 if a fault is detected in tripping circuit 1.

3.3 (Re)connection and special reconnections

3.3.1 (Re)connection and monitoring of the conditions

When the (re)connection conditions are fulfilled and the delay time for connection ($t_{(ON)NORMAL}$) has elapsed, the VMD460-NA enables the coupling of the generating plant to the network automatically.

The (re-)connection conditions are fulfilled as soon as the measured voltage values are within the range of the parameters $U_{(ON)MIN}$ to $U_{(ON)MAX}$ and the measured frequency values are within the range of the parameters $f_{(ON)MIN}$ to $f_{(ON)MAX}$ and all activated protective and monitoring functions have been reset.

If no connection value is set, the respective response value of the corresponding protective function applies. It must be ensured that the response values of the protective functions do not collide with those of the connection conditions.

3.3.2 Exceptions of automatic (re-)connection

In the event of a detected fault in one of the tripping circuits (interface switch fault), the connection is controlled via the parameter "Menu -> Settings -> Dig. in. -> Fault memory".

- Fault memory disabled:
If the fault is no longer present and the connection conditions have been fulfilled, the VMD460-NA reconnects after the delay time for connection has elapsed. Up to 3 automatic reconnection attempts are made in the event of a repeated interface switch fault. If these also fail, a manual RESET is required.
- Fault memory enabled:
If a fault is detected, there is no automatic (re-)connection or connection attempt. The fault must be acknowledged manually via the RESET button to enable a connection.

3.3.3 Special reconnections

It is possible to define special reconnection conditions for the events listed below.

3.3.3.1 Reconnection after short interruptions

Menu: 3. Settings-> 1. General ->:

5. $t_{\text{SHORT INT.}}$

6. $t_{\text{<ON> SHORT INT.}}$

A short interruption occurs when the reconnection conditions are fulfilled within a short period of time ($t_{\text{SHORT INT.}}$) after disconnection.

In case of a short interruption, automatic reconnection takes place with a shortened delay time ($t_{\text{<ON> SHORT INT.}}$).

3.3.3.2 Reconnection after df/dt detection (ROCOF)

Menu: 3. Settings -> 4. df/dt ->:

6. $t_{\text{<ON>}}$

If the VMD460-NA has been disconnected due to a df/dt detection, it reconnects after the separate delay time for connection $t_{\text{<ON>}}$ has elapsed. If $t_{\text{<ON>}}$ is set to "off", reconnection takes place after the delay time for connection $t_{\text{<ON>NORMAL}}$ has elapsed.

3.3.3.3 Reconnection after vector shift detection

Menu: 3. Settings-> 5. Vect.shift. ->:

4. $t_{\text{<ON>}}$

If the VMD460-NA has been disconnected due to a vector shift detection, it reconnects after the separate delay time for connection $t_{\text{<ON>}}$ has elapsed. If $t_{\text{<ON>}}$ is set to "off", reconnection takes place after the delay time for connection $t_{\text{<ON>NORMAL}}$ has elapsed.

3.4 Protective and monitoring functions

3.4.1 Voltage protection functions $U<$, $U<<$, $U>>$ and $U>$

The following voltage protection functions are implemented in the VMD460-NA:

- Over voltage protection: $U>>$ and $U>$
- Under voltage protection: $U<<$, $U<$

Depending on the coupling, all available phase voltages and line-to-line voltages (U_{L1-N} , U_{L2-N} , U_{L3-N} , U_{L1-L2} , U_{L2-L3} and U_{L3-L1}) are evaluated separately by the voltage protection functions (OR operation).

3.4.1.1 Over voltage protection, $U_{>>}$ and $U_{>}$

Menu: 3. Settings → 2. Voltage →:

1. $U_{>>}$ and 2. $t_{(OFF)}$

3. $U_{>}$ and 4. $t_{(OFF)}$

In the case of over voltage protection, the measured value is compared to the response value ($U_{>>}$ and $U_{>}$). If the measured value exceeds the response value for the duration of the corresponding response delay, the protective function is tripped. If the measured value falls below the response value, the protective function is reset.

The measured value is equal to the instantaneous value.

The implementation of the over voltage protection $U_{>}$ depends on the set application standard.

Please observe that:

In the following application standards, the $U_{>}$ measured value corresponds to a 10-minute mean value, which is calculated by averaging 3-second measuring intervals over 10 minutes. The mean value is determined as follows:

- CEI 0-21
The measured value is a root-mean-square value acc. to IEC EN 61000-4-30.
- VDE-AR-N 4105 and DIN V VDE V 0126-1-1
The measured value is an arithmetical average

3.4.1.2 Under voltage protection, $U_{<<}$ and $U_{<}$

Menu: 3. Settings → 2. Voltage →:

7. $U_{<}$ and 8. $t_{(OFF)}$

9. $U_{<<}$ and 10. $t_{(OFF)}$

In the case of under voltage protection, the measured value is compared to the response value ($U_{<}$ or $U_{<<}$). If the measured value falls below the response value for the duration of the corresponding response delay ($t_{(OFF)}$), the protective function is tripped.

If the measured value exceeds the response value, the protective function is reset.

The measured value is equal to the instantaneous value.

3.4.2 Frequency protection functions $f_{<}$, $f_{<<}$, $f_{>>}$ and $f_{>}$

The following frequency protection functions are implemented in the VMD460-NA:

- Frequency increase protection $f_{>}$, $f_{>>}$
- Frequency decrease protection $f_{<}$, $f_{<<}$

3.4.2.1 Frequency decrease protection $f<$, $f<<$

Menu: 3. Settings- \rightarrow 3. Frequency - \rightarrow :

7. $f<$ and 8. $t_{(OFF)}$

9. $f<<$ and 10. $t_{(OFF)}$

In the case of frequency decrease protection, the measured value is compared to the response value ($f<$ or $f<<$). If the measured value falls below the response value for the duration of the corresponding response delay ($t_{(OFF)}$), the protective function is tripped.

If the measured value exceeds the response value, the protective function is reset.

3.4.2.2 Frequency increase protection $f>$, $f>>$

Menu: 3. Settings- \rightarrow 3. Frequency - \rightarrow :

1. $f>>$ and 2. $t_{(OFF)}$

3. $f>$ and 4. $t_{(OFF)}$

In the case of frequency increase protection, the measured value is compared to the response value ($f>>$ or $f>$). If the measured value exceeds the response value for the duration of the corresponding response delay ($t_{(OFF)}$), the protective function is tripped.

If the measured value exceeds the response value, the protective function is reset.

3.4.3 Anti-islanding detection / loss of mains (LOM), df/dt (ROCOF), vector shift detection

The VMD460-NA uses a passive method for Anti-islanding detection / (LOM). The following methods are available:

- Three-phase voltage monitoring, refer to voltage protection functions
- Rate of Change of Frequency (ROCOF) df/dt
- Vector shift detection



Particularities of VDE-AR-N 4105:2018-11 (4105_2; profiles 1 and 2)

If it has been detected that dynamic network support is required, Anti-islanding detection / (LOM) is disabled for 8 seconds, suppressing unwanted disconnection from the network.

3.4.3.1 Rate of Change of Frequency (ROCOF) df/dt

Menu: 3. Settings -> 4. df/dt ->:

1. Function
2. Response value
3. Hysteresis
4. Meas. window
5. $t_{(OFF)}$
6. $t_{(ON)}$

In the case of the ROCOF method, the df/dt measured value (Rate Of Change Of Frequency) is compared to the response value. If the measured value exceeds the response value for the duration of the corresponding response delay ($t_{(OFF)}$), the protective function is tripped.

If the df/dt measured value falls below the response value by the hysteresis, the protective function is reset.

The df/dt detection can be enabled or disabled via the "Function" parameter.

The interval for averaging of the df/dt measured values is set via the "Meas. window" parameter.

The parameter " $t_{(ON)}$ " can be used to set a separate reconnection delay after a df/dt disconnection, see also ...

3.4.3.2 Vector shift detection

Menu: 3. Settings-> 5. Vect.shift ->:

1. Function
2. Response value
3. $t_{(START-UP)}$
4. $t_{(ON)}$

The vector shift detection detects phase displacements (vector shift) in the network voltage.

if the φ measured value exceeds the response value, the protective function is tripped.

After successful connection, the vector shift detection is blocked or suppressed for the duration of the delay time $t_{(START-UP)}$, so that transient phenomena caused by connection do not trip the protective function.

The function can be set to "off" via the "Function" parameter or the behaviour of the vector shift detection can be set:

- "L1", "L2", "L3": The protective function monitors the set phase



If "IAC" is set as coupling, "L1" is automatically monitored, even though the "Function" parameter still displays the last value set.

- "single": The protective function monitors each phase separately (OR operation)
- "all": A vector shift must occur simultaneously on all (three) phases

The " t_{ON} " parameter can be used to set a separate reconnection delay after a vector shift disconnection.

3.4.4 Unbalance detection

```
Menu: 3. Settings-> 5. Unbalance:
1. Function
2. Response value
3. Hysteresis
4.  $t_{\text{OFF}}$ 
```

On one hand, the unbalance is determined separately on the basis of the phase voltages among each other and on the other hand, on the basis of the line-to-line voltages among each other. If the unbalance measured value exceeds the set response value for the duration of the delay time (t_{OFF}), the protective function is tripped.

If the unbalance measured value falls below the response value by the hysteresis, the protective function is reset. The unbalance detection can be enabled or disabled via the "Function" parameter.

3.4.5 Monitoring of the tripping circuits and interface switches by means of contact feedback

```
Menu: 3. Settings-> 8. Dig.in.:
1. Mode
2.  $t_{\text{START-UP}}$ 
3. Fault memory
```

The digital contacts D1 and D2 can be used to monitor the tripping circuits (K1 -> interface switch 1 -> D1 and K2 -> interface switch 2 -> D2).

The VMD460-NA monitors and compares the contact positions of K1 and D1 as well as K2 and D2, and deduces faults in the tripping circuits.

If the VMD460-NA is connected, it checks the contact positions after the time delay ($t_{\text{START-UP}}$) has elapsed. Increasing the value may be necessary, e.g. for slow motor-operated interface switches.

If the VMD460-NA has disconnected, it checks the contact positions after 500 ms.

The "Mode" parameter is used to define the operating mode ("NO" or "NC") of the digital contacts or to disable the function ("off").

The " $t_{\langle \text{START-UP} \rangle}$ " parameter defines a time delay after which the contact position is checked subsequent to connection.

The "Fault memory" parameter can be used to define the disconnection behaviour in the event of a detected fault in the tripping circuits. If the fault memory is "enabled", the VMD460-NA does not perform an automatic (re-)connection or any connection attempts. To reconnect, the fault in the tripping circuit (interface switch fault) must be manually acknowledged and reset via the RESET button.

3.4.6 Remote trip: remote disconnection via ripple-control receiver

Menu: 3. Settings → 1. General →:
8. Remote trip

A remote trip signal can be connected to the RTG1 and RTG contacts for remote disconnection, e.g. via a ripple-control receiver.

If a remote trip signal is applied to the RTG1 and RTG contacts, the VMD460-NA trips relay K1 (and if necessary K2) after ≤ 50 ms and the alarm LEDs light up.

3.4.7 Test function for checking the tripping circuit, the interface switch and for determining the connection times

The self test is started by pressing the test button. It can only be started manually when the VMD460-NA has been connected (both alarm LEDs off).

The VMD460-NA disconnects during the self test. When interface switch monitoring/contact feedback is enabled and connected, the disconnection time is measured and displayed.



Particularities of VDE-AR-N 4105:2018-11 (4105_2)

First, disconnection path 2 is disconnected via K2. 5 s later, disconnection path 1 is disconnected via K1. The test takes approx. 10 s.

When interface switch monitoring/contact feedback is enabled and connected, the disconnection time is measured and displayed for each of the two relays. This ensures that the second disconnection path can also be tested.

3.4.8 Automatic self test

The device runs a continuous self test during which internal malfunctions are detected and shown on the display as error codes. As soon as the VMD460-NA detects an internal malfunction, it issues a disconnection command.

3.5 Other functions

3.5.1 Password protection

```
Menu: 4. System -> :
      4. Password
```

The password protection is disabled by default. If no password is set, all parameters and device settings can be freely changed and configured.

It is possible to navigate through the menu even if the password protection is enabled. The following parameters can always be changed (without entering a password): History, Language, TEST and RESET.

To change parameters, a password is required. A password remains active until exiting the menu. After 5 minutes of inactivity, the menu is exited automatically.

3.5.1.1 Single-stage password protection (system password)

The single-stage password protection is always available. After entering the correct "System" password, all parameters can be changed.

3.5.1.2 Two-stage password protection (system and standard password)

An additional "standard" password is available for VDE-AR-N 4105:2018-11 (4105_2). The "system" password is generally requested during/before parameter **input**. If the entry of a parameter is confirmed when the "standard" password is set, the rights are checked again and, if necessary, the "standard" password has to be entered. The parameters of the standards in the "Settings" menu can be viewed when the "standard" password is set, but can only be changed to a limited extent. History memory: The last 300 network faults can be called up with time stamp/real-time clock.



*In general, **no** changes can be made to parameters of the standard (settings) on this access level if the "standard" password is set. The following parameters are **exceptions** according to the VDE-AR-N 4105:2018-11 standard: response value "U>" (profiles 1...3), and response delays "t_{off U<}" and "t_{off U<<}" (profile 2 only).*

3.5.2 Protection against unauthorised access - sealable enclosure

The VMD460-NA can be sealed to prevent or detect unauthorised access.

3.5.3 Reset device to factory settings

Menu: 4. System -> 12. Factory settings

Via this menu, the device can be reset to the factory settings.

3.5.4 History memory of the last 300 faults with time stamp (real-time clock)

Menu: 2. History

The history memory saves up to 300 events (alarms, tests) with information on messages (e.g. event code and/or measured value), acknowledgements and the corresponding date and time. If the history memory is full, the oldest entry will be deleted in the event of an alarm to make space for the new entry (FIFO principle).

The history memory can be deleted or reset in the menu: 4. System -> 1. History.

4. Installation, connection and commissioning



Danger of electric shock!

*Make sure that the installation area is **disconnected from any electrical source**.*

*Consider the data on **the rated voltage and supply voltage** as specified in the technical data!*

4.1 Unpacking

- Unpack all the parts supplied with the system. Do not use sharp-edged tools that may damage the content of the packaging.
- Compare your order with our delivery note to check that you have received all products in full. The article numbers and type designation printed on the nameplates provides an easy means of uniquely identifying each device.
- Check all parts supplied for any evidence of damage in transit.
- Devices damaged in transit must not be used. If a device has sustained damage, please contact Bender. Details of who to contact are indicated on the delivery document.
- When storing the devices in an environment where the temperature is wintry and cold: Leave the devices to stand for 3 to 4 hours at room temperature before connecting the power supply. When the devices are moved from a cold to a warm environment, condensation will be evident on all parts. Putting damp devices into operation may damage electrical components and there is a danger of electric shock on contact.

4.2 Fuses

Equip the supply voltage of all system -components with fuses. IEC 60364-4-473 requires protective devices to be used to protect the component in the event of a short circuit. We recommend the use of 6 A fuses.

4.3 Installation instructions



Danger of electric shock!

*Make sure that the installation area is **disconnected from any electrical source**.*

*Consider the data on **the rated voltage and supply voltage** as specified in the technical data!*



*The **length of the connecting cable** of the device connections DG1/2, D1, D2, DG3/4, D3, D4, RTG and RT1 is to be limited to **3 m**.*

*In order to ensure the proper functioning of the VMD460-NA after a power failure, an **external UPS** is to be used.*

In this case, the following exception applies:

If a delay or disconnection time smaller than the bridging time is configured for under voltage protection ($U <$ or $U <<$), no external UPS must be provided for the supply voltage. The bridging time is 600 ms at a supply voltage $U_s = 230\text{ V}$.

This applies, for example, to the following default profiles:

VDE-AR-N 4105:2018-11; VDE-AR-N 4105:2011-08; G59/3, G83/2; G59/2; VDE-AR-N 4110:2018-11 Profile 4; BDEW guideline; 0126; CEI 0-21

The devices are suitable for the following installation methods:

- Standard distribution panels in accordance with DIN 43871 or quick DIN rail mounting in accordance with IEC 60715
- Screw mounting using M4 screws

4.4 Principle diagrams



Abb. 4.1: Schematic diagram of a central NS protection according to VDE-AR-N 4105:2018-11



Abb. 4.2: Schematic diagram of a central NS protection with interface switches

4.5 Dimension diagram VMD460-NA

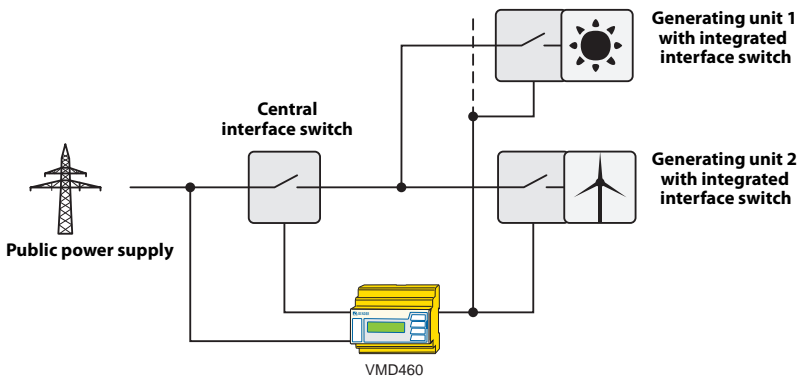
All dimensions in mm

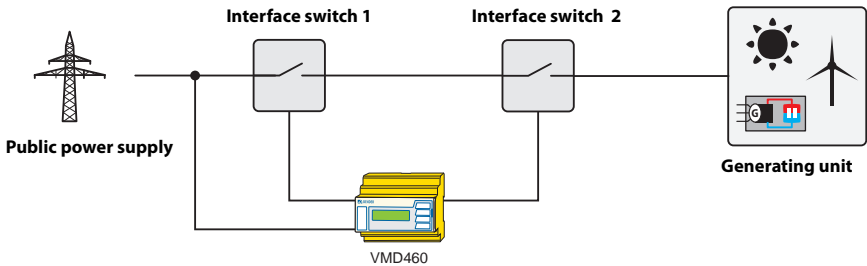
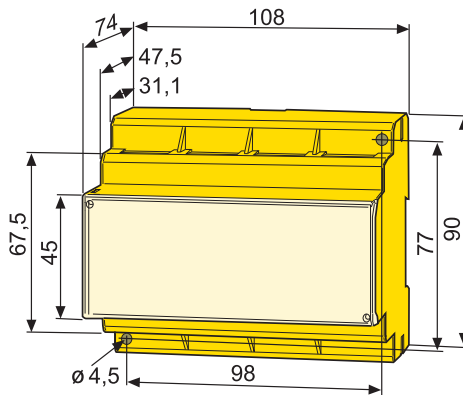

Fig. 4.3: Dimension diagram and drawing for screw mounting

4.6 DIN rail mounting

Snap the rear mounting clip of the device into place in such a way that a safe and tight fit is ensured.

4.7 Screw mounting

1. Use a tool to position the rear mounting clips so that they project beyond the enclosure (a second mounting clip is required, see ordering details).
2. Then fix the device using two M4 screws.

4.8 Wiring diagrams

Depending on the applicable standard, connect the device according to the wiring diagram.



The following wiring diagrams are recommendations by Bender. Other wiring options are possible in the context of the applicable standard.

4.8.1 VDE-AR-N 4105:2018 – basic program 4105_2

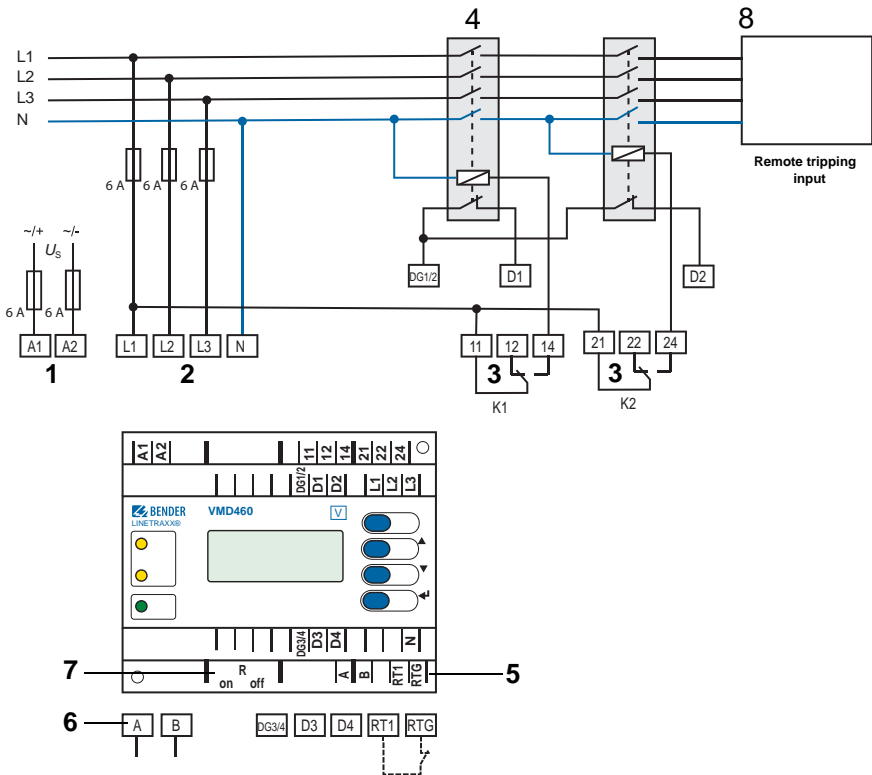



Fig. 4.4: Wiring diagram VMD460-NA - basic program 4105_2

Wiring diagram legend

No.	Element	Function
1	A1, A2	Supply voltage U_s (see ordering details)
2	L1, L2, L3, N	Power supply connection
3	K1, K2	Relay connections
4	DG1/2, D1	Central interface switch with contact monitoring D1: Feedback signal contact K1 (feedback signal contacts optionally NC/NO/off)*
5	RTG, RT1	RTG: GND RT1: remote trip input (optionally NC/NO/off)*
6	A, B	Service interface
7	R_{on/off}	Activate or deactivate the terminating resistor of the service interface (120 Ω)
	DG3/4, D3, D4	Not used for these standards
8	DG1/2, D2	Generating unit (in this case PV inverter with an integrated interface switch and contact monitoring) D2: Feedback signal contact K2 (feedback signal contacts optionally NC/NO/off)*

* Explanation: **NC** (in non-operating state closed) 

NO (in non-operating state open) 

off (switched off)



The interface switch is monitored by means of contact feedback. Faulty conditions such as welded contactor contacts can thus be detected.

4.8.2 VDE-AR-N 4105:2018 – basic program 4105_2 with several generating units

In this wiring diagram, two generating units (in this case PV inverters) are shown as examples.

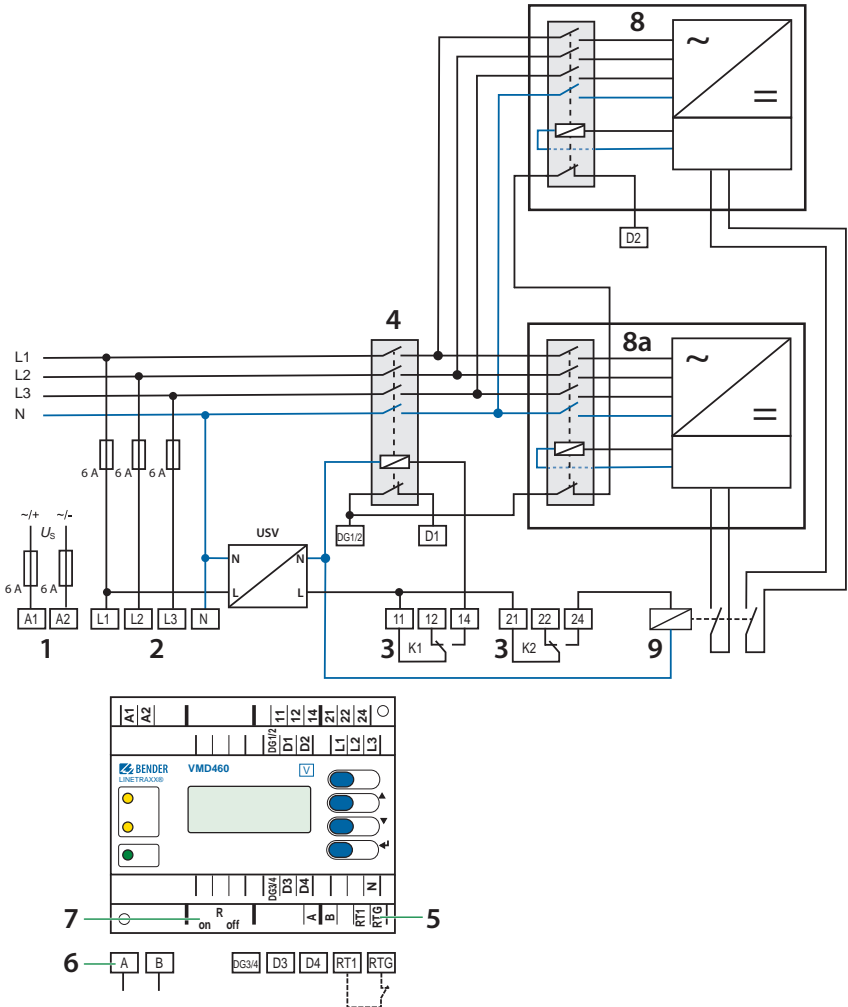



Fig. 4.5: Wiring diagram VMD460-NA - basic program 4105_2 with several generating units

In principle, an extension to several generating units is possible. For this purpose, further generating units must be integrated into the signal chain of the tripping circuit via relay K2 and the contact feedback via D2 accordingly.

Wiring diagram legend

No.	Element	Function
1	A1, A2	Supply voltage U_s (see ordering details)
2	L1, L2, L3, N	Power supply connection
3	K1, K2	Relay connections
4	DG1/2, D1	Central interface switch with contact monitoring D1: Feedback signal contact K1 (feedback signal contacts optionally NC/NO/off)*
5	RTG, RT1	RTG: GND RT1: remote trip input (optionally NC/NO/off)*
6	A, B	Service interface
7	$R_{on/off}$	Activate or deactivate the terminating resistor of the service interface (120 Ω)
	DG3/4, D3, D4	Not used for these standards
8, 8a	D2	Generating unit (in this case PV inverter with an integrated interface switch and contact monitoring) D2: Feedback signal contact to relay 2 (feedback signal contacts optionally NC/NO/off)*
9	24	Remote tripping output via relay K2

* Explanation: **NC** (in non-operating state closed) 
NO (in non-operating state open) 
off (switched off)



The interface switch is monitored by means of contact feedback. Faulty conditions such as welded contactor contacts can thus be detected. If the feedback signal contacts are designed as NC contacts, they must be connected in series to the contact monitoring (see illustration). If the feedback signal contacts are designed as NO contacts, they must be connected in parallel to the contact monitoring.

4.8.3 VDE-AR-N 4110:2018-11 – basic program 4110

Application/Use: higher-level decoupling protection of the generating plant without QU protection in the context of VDE-AR-N 4110:2019-11.

Automatic reconnection is not permitted after a disconnection due to a tripped protective or monitoring function of the generating plant. Reconnection may only take place after approval by the network control centre. (VDE-AR-N 4110:2018-11 chapter 10.4.2 par. 1)

In order to meet this requirement with the VDM460-NA, the use of the remote trip function (remote disconnection) in conjunction with an external circuit must be implemented. The following wiring diagram and the corresponding explanation is only one possible example:

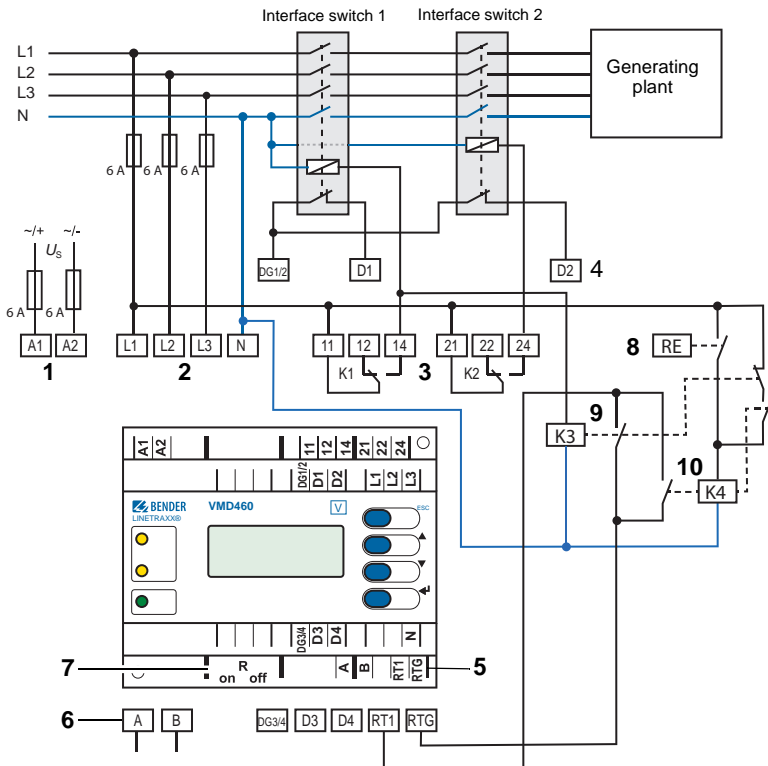

Fig. 4.6: Example of connection according to VDE-AR-N 4110:2019-11

Explanation

Initial state: The system is disconnected. RT1 and RTG have no connection. This keeps the VMD460-NA in the alarm state (remote trip active).



The ripple-control receiver gets an impulse from the network control centre and operates relay K4, which goes into self-locking mode. From now on, reconnection is enabled (reconnection depends on VMD460-NA: fault, alarm, delay time for connection etc...).

As soon as the VMD460-NA reconnects the system, relay K3 is operated. This ensures that RT1 and RTG remain connected and that relay K4 is de-energised.

If at any time the VMD460-NA is triggered, the connection of RT1 and RTG is terminated and the device remains in the alarm state until it is released again by the ripple-control receiver.

Wiring diagram legend

No.	Element	Function
1	A1, A2	Supply voltage U_s (see ordering details)
2	L1, L2, L3, N	Power supply connection
3	K1, K2	Relay connections
4	DG1/2, D1, D2	Contact monitoring interface switch DG1/2: GND D1: Feedback signal contact K1 D2: Feedback signal contact K2 (feedback signal contacts optionally NC/NO/off)*
5	RTG, RT1	RTG: GND RT1: remote trip input (optionally NC/NO/off)*
6	A, B	Service interface
7	R_{on/off}	Activate or deactivate the terminating resistor of the service interface (120 Ω)
8	RE	Ripple-control receiver
9	K3	External relay with an NC contact and an NO contact
10	K4	External relay with two NO contacts
	DG3/4, D3, D4	Not used for this standard

* Explanation: **NC** (in non-operating state closed) 
NO (in non-operating state open) 
off (switched off) 



Use contact monitoring to ensure that there is no operation with welded contactor contacts!

4.8.4 EREC G99, G98, C10/11, DIN V VDE V 0126-1-1 basic programs G98, G99, C10/11, 0126

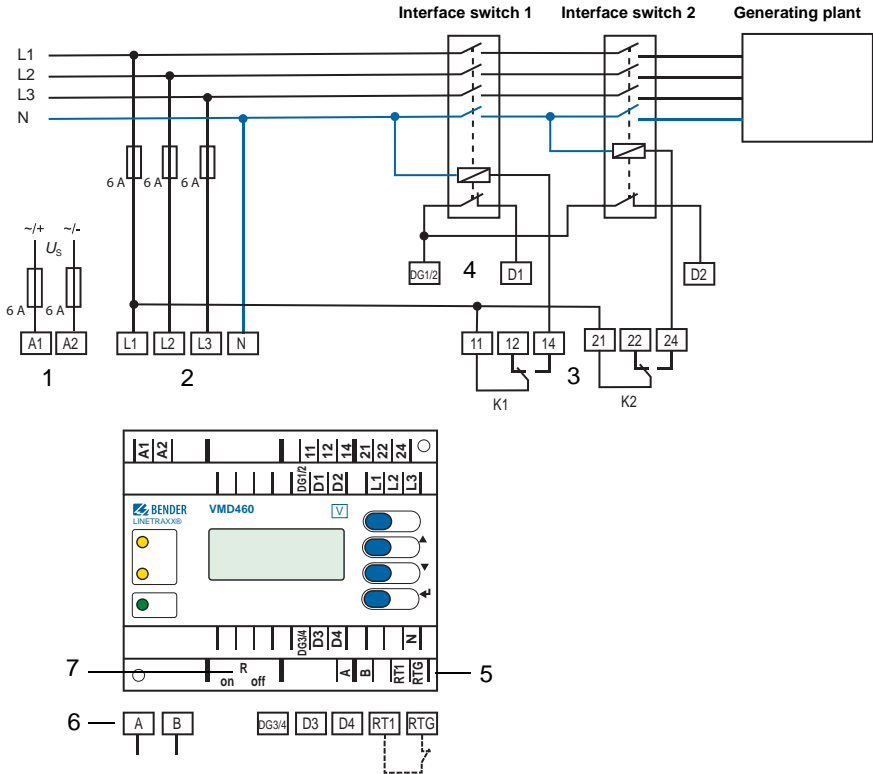



Fig. 4.7: Wiring diagram VMD460-NA
(basic programs G98, G99, C10/11, 0126)

Wiring diagram legend

No.	Element	Function
1	A1, A2	Supply voltage U_s (see ordering details)
2	L1, L2, L3, N	Power supply connection
3	K1, K2	Relay connections
4	DG1/2, D1, D2	Interface switch with contact monitoring D1: Feedback signal contact K1 D2: Feedback signal contact K2 (<i>feedback signal contacts optionally NC/NO/off</i>)*
5	RTG, RT1	RTG: GND RT1: remote trip input (<i>optionally NC/NO/off</i>)*
6	A, B	Service interface
7	R_{on/off}	Activate or deactivate the terminating resistor of the service interface (120 Ω)
	DG3/4, D3, D4	Not used for these standards

* Explanation: **NC** (in non-operating state closed) 

NO (in non-operating state open) 

off (switched off).



The interface switch is monitored by means of contact feedback. Faulty conditions such as welded contactor contacts can thus be detected.

4.8.5 CEI 0-21

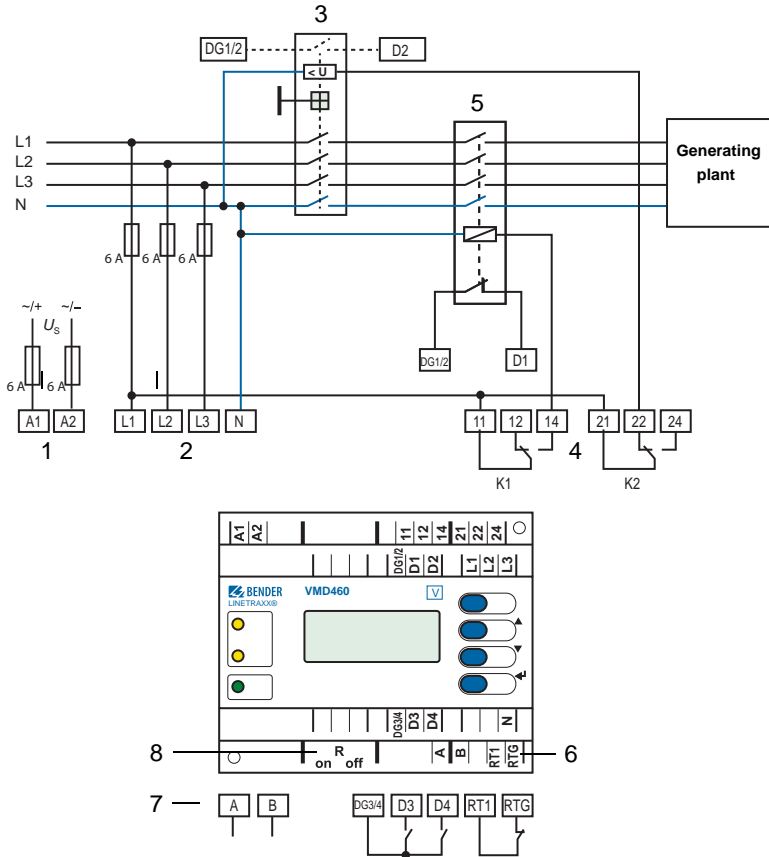

Fig. 4.8: Wiring diagram VMD460-NA (CEI 0-21)

Wiring diagram legend

No.	Element	Function
1	A1, A2	Supply voltage U_s (see ordering details)
2	L1, L2, L3, N	Power supply connection
3	DG1/2, D1, D2	Contact monitoring interface switch DG1/2: GND D1: Feedback signal contact K1 D2: Feedback signal contact K2 (backup) <i>(feedback signal contact optionally NC/NO/off)*</i>
4	K1, K2	Relay connections
5	DG3/4, D3, D4	Digital inputs (external monitoring) DG3/4: GND D3: local control (CEI 0-21 8.6.2.1.1)** D4: external signal (CEI 0-21 8.6.2.1.2)** <i>(optionally NC/NO/off)*</i>
6	RTG, RT1	RTG: GND RT1: remote trip input <i>(optionally NC/NO/off)*</i>
7	A, B	Service interface
8	R_{on/off}	Activate or deactivate the terminating resistor of the service interface (120 Ω)

Explanations :

* **NC** (in non-operating state closed) 

NO (in non-operating state open) 

off (switched off)

** In order to evaluate the **inputs D3 and D4** the mode can be adjusted correspondingly in the menu (menu: 3. Settings --> 1. General --> 4. Mode):

Example for NO:

Connection **D3**, mode: local (D4 not evaluated)

D3: local control	f [Hz]	Disconnection time	Parameter
Open	49.5...50.5	0.1 s	81.S1
Closed	47.5...51.5	0.1 s	81.S2

Example for NO:

Connection **D4**, mode: external (D3 not evaluated)

D4: external signal	f [Hz]	Disconnection time	Parameter
Open	49.5...50.5	0.1 s	81.S1
Closed	47.5...51.5	4 s; 1 s	81.S2



In the event of a fault in interface switch 1 (K1), the contact monitoring causes the backup relay (K2) to switch.

4.8.6 Details regarding the digital inputs (D1...D4, RT1)

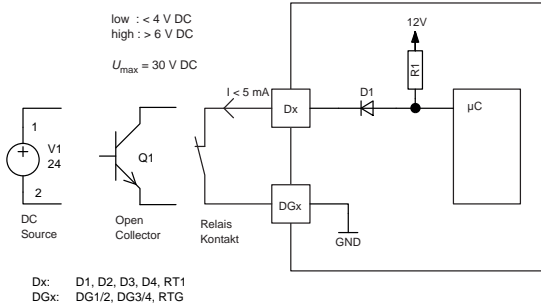

Fig. 4.9: Block diagram (simplified representation)

4.8.7 Further standards

- VDE-AR-N 4105:2011-08 – basic program 4105_1
- BDEW
- G59/3
- G83/2

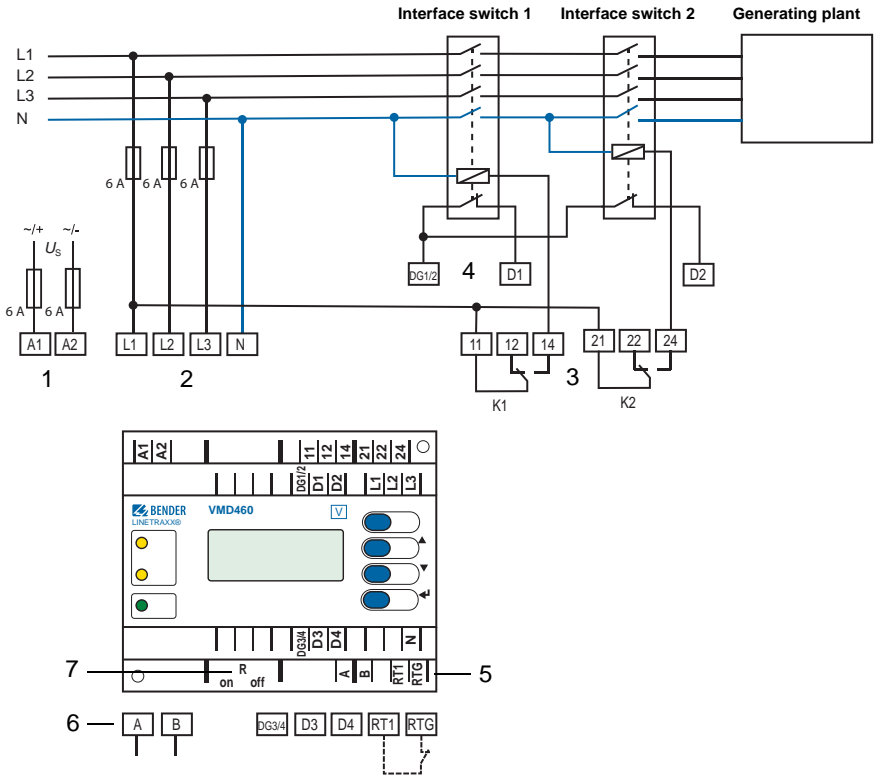



Fig. 4.10: Wiring diagram VMD460-NA
(basic programs 4105_1, BDEW, G59/3, G83/2)

Wiring diagram legend

No.	Element	Function
1	A1, A2	Supply voltage U_s (see ordering details)
2	L1, L2, L3, N	Power supply connection
3	K1, K2	Relay connections
4	DG1/2, D1, D2	Interface switch with contact monitoring D1: Feedback signal contact K1 D2: Feedback signal contact K2 <i>(feedback signal contacts optionally NC/NO/off)*</i>
5	RTG, RT1	RTG: GND RT1: remote trip input <i>(optionally NC/NO/off)*</i>
6	A, B	Service interface
7	R_{on/off}	Activate or deactivate the terminating resistor of the service interface (120 Ω)
	DG3/4, D3, D4	Not used for these standards

* Explanation: **NC** (in non-operating state closed) 

NO (in non-operating state open) 

off (switched off).



The interface switch is monitored by means of contact feedback. Faulty conditions such as welded contactor contacts can thus be detected.

4.9 Commissioning



Danger of electric shock!

Improper connection can lead to serious injury to persons or damage to property!

*Prior to commissioning **make sure that the device is properly connected!***

Initial commissioning

When commissioning the device for the first time you have to:

- Select a **language**.
- Select a **standard** (refer to [Chapter 6. "Basic programs"](#)).
- Set the **date** and **time**.

These settings are necessary before you can make changes in the different menus.



*The **contrast of the LC display** can be adjusted to any ambient brightness. Select the contrast ratio from an infinite loop display. Simultaneously press and hold down the buttons "INFO" and "MENU" until the display text is clearly readable. After reaching a black display, the contrast setting process starts again with a white display.*

*When the application standard is changed, the associated factory settings will be loaded. Existing **user-defined settings will not be stored when the application standard is changed.***

4.10 Tripping circuit test by the system installer

During commissioning, the system installer has to check the correct function of the tripping circuit NS protection/interface switch, as illustrated in the wiring diagram in this operating manual, consisting of K1/K2 and interface switch 1/interface switch 2.

- Press the test button to activate the interface switches.
- Successful activation must be visualised by the interface switch.
- Contact monitoring of the interface switches (optional, depending on the standard)

Observe the information on recurrent tests on Page 49.

5. Operation and settings

5.1 User interface

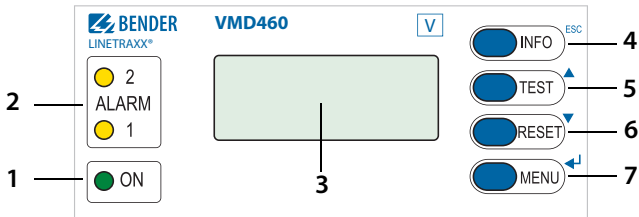

Legend

No.	Element	Function
1	ON	Power On LED, green; lights when the voltage supply is available and the device is in operation; flashes when the device is being started or when an internal device error has occurred
2	ALARM1 ALARM2	System disconnected: Both LEDs light (yellow) in the case of a limit value violation of voltage or frequency, remote disconnection (remote trip, optional), df/dt (optional), vector shift detection (optional), unbalance (optional); Both LEDs flash (yellow) in the case of an internal device error or fault in the contact monitoring Only ALARM 1 lights: Reconnection conditions met. $t_{(ON)}$ elapses
3		Backlit LC display
4	INFO ESC	Standard display: Standard display and device information Menu display: Exit the parameter setting menu without saving; go to the next higher menu level
5	TEST ▲	Standard display: Pressing the TEST button (> 1.5 s) starts a manual self test which triggers both alarm relays (tripping test to check the interface switches). In addition, the disconnection times are documented. Refer to "Manual self test" on page 74. Menu display: Arrow-up button for parameter change and scrolling
6	RESET ▼	Standard display: (> 1.5 s) Acknowledge fault messages from contact monitoring Menu display: Arrow-down button for parameter change and scrolling
7	MENU ◀	Standard display: Toggle between standard, menu and alarm display Menu display: ◀ button Jump to setting parameter; save changes

5.2 Display indications

5.2.1 Standard display

In the standard display, line-to-line voltages, phase voltages, the highest 10-minute-phase voltage mean value U_{10LN} (depending on the standard) and the frequency are indicated on the display.

L1-N 229.9V	L1-L2
397.2V	
L2-N 229.5V	L2-L3

Fig. 5.1: Standard display

5.2.2 Info display

Device-specific information is indicated on the info display.

VMD460-NA
22.02.20 12:34
Address: xx

Fig. 5.2: Info display

For detailed information, refer to "INFO button" on page 43.

5.2.3 Alarm display

Type and source of alarms are indicated on the alarm display in clear text format.

ALARM	2/3
● Undervoltage	
$U_{(N-1)}$: 180.3 V	

Fig. 5.3: Alarm display

Explanation: In the example above, the second message of three is being indicated (2/3). The address "Addr.:" shows the BMS-bus address of the device sending the alarm. The alarm is output on measuring channel 1 and can be accessed via channel number 1 in the "Alarm/meas. values" menu.

5.2.4 Menu display

Alarms, present measured values as well as the history memory can be called up via the menu display. Settings can also be changed in this display.

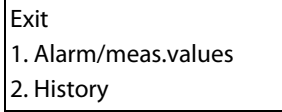

Fig. 5.4: Menu display

5.2.5 Toggling between the individual displays

Toggle between the different displays using the four device buttons. Depending on the type of display (standard display, alarm display, menu display, info display), the meaning of the buttons is different. The picture below illustrates which button is to be pressed for accessing the individual display.

First, it is necessary to distinguish between an alarm condition and no alarm condition.

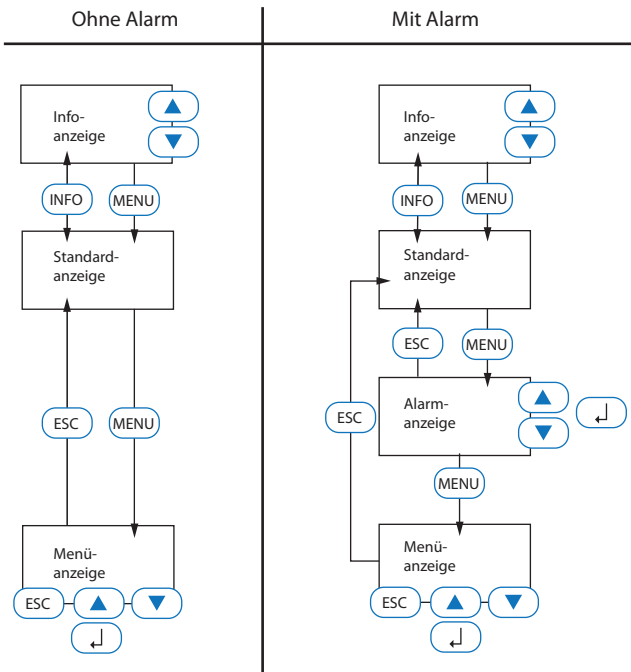

Fig. 5.5: Toggling between the displays (alarm condition or no alarm condition)

5.3 INFO button

Device information in clear text format (Info display) can be called up with the "INFO" button. For this purpose press the "INFO" button in the standard display once.

Scroll through the individual lines using the arrow buttons ▲▼ :

1.	Device name
2.	Current date and time
3.	BMS bus address
4.	Software version, measurement technology
5.	Software date, measurement technology
6.	Software version, display
7.	Software date, display
8.	Manufacturer of the device
9.	Address of the manufacturer
10.	Internet address of the manufacturer

Return to standard display via "ESC" or ←.

5.4 MENU button



Toggle between the standard, alarm and menu display. (Refer to "Toggling between the displays (alarm condition or no alarm condition)" on page 42.)

The individual entries in the menu display can be accessed using the arrow buttons ▲▼ :

The **menu display** provides the following submenus:

Exit	
1.	Alarm/meas.values
2.	History
3.	Settings
4.	System
5.	Info

5.4.1 Alarm/ meas. values

A detailed query of the values can be found at *Menu: 1. Alarm/meas. values* (select menu item ) for detailed information about the values. Select the individual entries by means of the   buttons.

Measuring channel		Parameter	VALUE
1	<input checked="" type="radio"/>	$U_{(1-N)}$:	
2	<input checked="" type="radio"/>	$U_{(2-N)}$:	
3	<input checked="" type="radio"/>	$U_{(3-N)}$:	
4	<input type="radio"/>	U10LN:	
5	<input type="radio"/>	U10LL:	
6	<input checked="" type="radio"/>	$U_{(1-2)}$:	
7	<input checked="" type="radio"/>	$U_{(2-3)}$:	
8	<input checked="" type="radio"/>	$U_{(3-1)}$:	
9	<input type="radio"/>	Frequency:	
10	<input type="radio"/>	df/dt:	
11	<input checked="" type="radio"/>	Contact monitor. K1*	
12	<input type="radio"/>	$t_{(ON)}$:	
13	<input type="radio"/>	Unbalance:	
14	<input checked="" type="radio"/>	Vect.shift:	
15	<input checked="" type="radio"/>	Phase sequence:	
16	<input type="radio"/>	$t_{(OFF) TOT}^*$:	
17	<input type="radio"/>	$t_{(OFF) DEVICE}^*$	

4501_2

16	<input type="radio"/>	$t_{(OFF) K1}^{**}$	
17	<input type="radio"/>	$t_{(OFF) K2}^{**}$	

For each of these entries you can check whether an alarm exists or not:

= no alarm

= alarm

- * *Measuring channel 11*: The text depends on the existing messages. If several messages exist, individual messages are indicated alternately on the display every four seconds.
- * *Measuring channel 16*: Indicates the total time passed during the self test from simulating 0 V on L1 to **disconnecting** interface switch 1. (Refer to "Manual self test" on page 74.)
- * *Measuring channel 17*: Indicates the total time passed during the self test from simulating 0 V on L1 to the **disconnection command** for interface switch 1. (Refer to "Manual self test" on page 74.)

- ** Display of the measured time

5.4.2 History

The history memory stores up to 300 events (alarms, tests) with information about alarms and acknowledgements and the time the event happened. If the history memory is full, the oldest entry will be deleted in the event of an alarm to make space for the new entry (FIFO principle).

For details about erasing the entire history memory manually, refer to Chapter 5.4.4 "System" on Page 46.

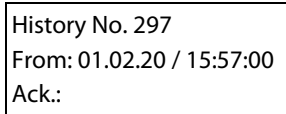



Fig. 5.6: History (overview)

Legend of "Figure Fig. 5.6: History (overview)"

- Line 1: Event number
- Line 2: Start of the event: Date/time
- Line 3: Acknowledgement of the event: Date/time
- Line 4: End of the event: Date/time

Possibilities:

1. If you are searching for an event that occurred at a specific time, scroll through the different entries using the arrow buttons.
2. Calling up details: Use the  button to call up the latest history memory entry.

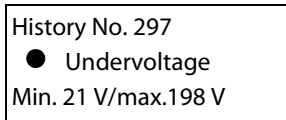

Fig. 5.7: History (detail)

Legend of "Figure Fig. 5.7: History (detail)"

- Line 1: Data record number
- Line 2: Alarm status and alarm text (e.g. undervoltage, current transformer error,...)
 - = no alarm
 - = alarm, fault
- Line 3: Minimum and maximum measured value after the occurrence of an alarm
- Line 4: BMS bus address and measuring channel of the device sending the signal

5.4.3 Settings





Response values for NS protection may only be changed in consultation with the system operator!

Settings can be password protected. If the password is enabled, all settings can still be displayed. When an attempt is made to change settings, the password entry screen appears automatically:

Please enter
password:
0 0 0

Once a valid password has been entered, access will be granted to settings in all menus until menu mode is exited.

If you cannot remember your password, contact the Bender service.



In principle, all preset response values can be changed, if this should be necessary. The values can be changed in the third level of the menu (column "twice ") using  .

There are two different ways to exit the setting menu:

- **Save** and exit: „“
- Exit **without saving**: "ESC"

The menu structures in the settings contain different entries for each individual standard. These are listed in detail in **Chapter 6. "Basic programs"**.

5.4.4 System

The following table gives an overview of the menu structure. The values can be changed in the third level of the menu ("twice ") using  .

There are two different ways to exit the system menu:

- Save and exit: „“
- Exit without saving: "ESC"

System menu overview

Menu: System	once ↵	twice ↵
1. History	Exit	
	1. Delete	Delete Cancel
2. Language	Exit	
	1. English 2. Deutsch 3. Italiano	
3. Clock	Exit	
	Format	d.m.y m-d-y
	Date	Toggling between date elements with ↵
	Time	Toggling between hour and minute with ↵
	Summer time	auto off
4. Password*	Exit	
	Password	* * * Toggling between positions with ↵
	State	off on
5. Interface	Exit	1...90
	Address	1: Master 2...90: Slave
6. Alarm addresses	Exit Address xxx	1...150; off; on
7. TEST	Cancel TEST	Test is carried out
8. RESET	Cancel RESET	Reset is carried out
9. Test communication	Exit	
	1. Channel	Channel (1...12)
10. External devices	Exit	
	List of connected devices	1...150: address of the VMD460-NA and external devices
11. Service	Service menu only available for the Bender service	
12. Factory settings	Cancel factory settings	Restore factory settings

* The VDE-AR-N 4105:2018-09 standard requires that the settings of the system and the standard are each secured with a separate password.

5.4.5 Info

The following table gives an overview of the information to be called up. Scroll through the individual lines using the arrow buttons ▲▼ :

1.	Device name
2.	Current date and time
3.	BMS bus address
4.	Software version, measurement technology
5.	Software date, measurement technology
6.	Software version, display
7.	Software date, display
8.	Manufacturer of the device
9.	Address of the manufacturer
10.	Internet address of the manufacturer

6. Basic programs



Response values for NS protection may only be changed in consultation with the system operator!

The following standards are implemented in the factory settings of the VMD460-NA:

Standard/application guide	Basic program	Profiles
VDE-AR-N 4105:2018-09	4105_2	1: Synchronous and asynchronous generators coupled directly or via a converter with $P_n \leq 50$ kW 2: Synchronous and asynchronous generators coupled directly with $P_n \geq 50$ kW 3: Converter
VDE-AR-N 4105:2011-08	4105_1	
VDE-AR-N 4110:2018-11	4110	1 (MV-busbar; higher-level generating plant) Protection of a generating plant at the network connection point when connected to the busbar * 2 (MV-busbar; generating unit) Protection at the generating unit when connecting the generating plant to the busbar of a substation 3 (MV-network; higher-level generating plant) Protection of a generating plant at the network connection point when connected to the medium-voltage network * 4 (MV-network; generating unit) Protection at the generating unit when connecting the generating plant to a medium-voltage network *) For profiles 1 and 3, the separate instructions for the intended use in Chapter 2.4 and the wiring diagram in Chapter 4.8.3 must be observed.
BDEW technical guideline 2008 with amendments until 01.2013	BDEW	
DIN V VDE V 0126-1-1:2006-02/A1:2012-02	0126	
CEI 0-21(:2012-06, :V1:2012-12, :V2:2013-12, :2014-09, :V1:2014-12, 2016-07, V1:2017-07)	CEI 021	
C10/11:2012-06	C10/11	
G98/1-4:2019	G98	
G83/2:2012 and G59/3:2013	G83/2	
G99/1-4:2019	G99	Type A, type B and type C power generation modules 1: Low-voltage protection (LV Protection) 2: High-voltage protection (HV Protection) Type D ... 3: Type D power generation modules and power plants with a registered capacitance of > 50 MW
G59/2(:2010, -1:2011)	G59/2	



Selecting a standard

MENU button --> 3. Settings --> 1. General --> 1. Standard

Loading a standard takes approximately five seconds and is indicated on the display by means of a progress bar. By default, the first profile is loaded for all standards whose settings can be made over several profiles.

Selecting a profile

MENU button --> 3. Settings --> 1. General --> 2. Profile



The settings for the different profiles are made according to the loading of a standard. The following tables give an overview of the menu structure for each preset standard. The values can be changed in the third level of the menu (column "twice ") using  .



Exit the respective menu item with
ESC (= without saving the changed parameter)
 (= saving the changed parameter)



User-defined settings will not be saved if the standard is changed.

6.1 VDE-AR-N 4105:2018-09

4105_2 Menu:	once 	twice 	Profile 1 ³⁾	Profile 2 ³⁾	Profile 3 ³⁾
Exit					
1. General	Exit				
	1. Standard	4105_2; 4105_1; 4110; BDEW; 0126; CEI021; C10/11; G98; G83/2; G99; G59/2	4105_2	4105_2	4105_2
	2. Profile	1...3	1	2	3
	3. Coupling	1 AC; 3N AC; 3 AC	3N AC	3N AC	3N AC
	4. $U_{(L-N)} / U_{(L-L)}$	50...260 V; 87...450 V	U(L-N) 230 V	U(L-N) 230 V	U(L-N) 230 V
	5. $t_{\text{SHORT INT.}}$	off; 40 ms...60 min	off	off	off
	6. $t_{(ON) \text{ SHORT INT.}}$	40 ms...60 min	---	---	---
	7. $t_{(ON) \text{ NORMAL}}$	40 ms...60 min	60 s	60 s	60 s
	8. Remote trip	NC; NO; off	off	off	off
2. Voltage	Exit				
	1. $U >>$	off; 100...150 %	115 %	125 %	125 %
	2. $t_{(OFF)}$	40 ms...60 min	100 ms	100 ms	100 ms
	3. $U >$	off; 100...150 %	110 %	110 %	110 %
	4. $t_{(OFF)}$	40 ms...60 min	100 ms	100 ms	100 ms
	5. $U_{(ON) \text{ MAX}}$	off; 100...150 %	off	off	off
	6. $U_{(ON) \text{ MIN}}$	off; 1...100 %	85 %	85 %	85 %
	7. $U <$	off; 1...100 %	80 %	80 %	80 %
	8. $t_{(OFF)}$	40 ms...60 min	100 ms	1.00 s	3.00 s
	9. $U <<$	off; 1...100 %	off	45 %	45 %
	10. $t_{(OFF)}$	40 ms...60 min	---	300 ms	300 ms
3. Frequency	Exit				
	1. $f >>$	off; 50.00...65.00 Hz	off	off	off
	2. $t_{(OFF)}$	40 ms...60 min	---	---	---
	3. $f >$	off; 50.00...65.00 Hz	51.50 Hz	51.50 Hz	51.50 Hz
	4. $t_{(OFF)}$	40 ms...60 min	100 ms	100 ms	100 ms
	5. $f_{(ON) \text{ MAX}}$	off; 50.00...65.00 Hz	50.1 Hz	50.1 Hz	50.1 Hz
	6. $f_{(ON) \text{ MIN}}$	off; 45.00...60.00 Hz	off	off	off
	7. $f <$	off; 45.00...60.00 Hz	47.50 Hz	47.50 Hz	47.50 Hz
	8. $t_{(OFF)}$	40 ms...60 min	100 ms	100 ms	100 ms
	9. $f <<$	off; 45.00...60.00 Hz	off	off	off
10. $t_{(OFF)}$	40 ms...60 min	---	---	---	

4105_2 Menu:	once 	twice 	Profile 1 ³⁾	Profile 2 ³⁾	Profile 3 ³⁾
4. df/dt	Exit				
	1. Function	off; on	off	off	off
	2. Resp. value	0.05...9.95 Hz/s	2.00 Hz/s	2.00 Hz/s	2.00 Hz/s
	3. Hysteresis	1.0...50.0 %	20.0 %	20.0 %	20.0 %
	4. Meas. window	50 ms...1 s	500 ms	500 ms	500 ms
	5. t _(OFF)	40 ms...60 min	100 ms	100 ms	100 ms
	6. t _(ON)	off 40 ms...60 min	off	off	off
5. Vect.shift	Exit				
	1. Function	off; L1; L2; L3;single; all	off	off	off
	2. Resp. value	1.0...25.0°	8.0°	8.0°	8.0°
	3. t _(START-UP)	off; 40 ms...60 min	2.00 s	2.00 s	2.00 s
	4. t _(ON)	off; 40 ms...60 min	off	off	off
6. Unbalance	Exit				
	1. Function	off; on	off	off	off
	2. Resp. value	1.0...50.0 %	5.0 %	5.0 %	5.0 %
	3. Hysteresis	1.0...50.0 %	20.0 %	20.0 %	20.0 %
	4. t _(OFF)	40 ms...60 min	100 ms	100 ms	100 ms
7. Relays	Exit				
	1. Relay mode ¹⁾	NC; NO	K1: NC K2: NC	K1: NC K2: NC	K1: NC K2: NC
8. Dig. input	Exit				
	1. Mode	NC; NO; off	D1: NC D2: NC D3: ___ ²⁾ D4: ___ ²⁾	D1: NC D2: NC D3: ___ ²⁾ D4: ___ ²⁾	D1: NC D2: NC D3: ___ ²⁾ D4: ___ ²⁾
	2. t _(START-UP)	40 ms...60 min	D1: 500 ms D2: 500 ms D3: ___ ²⁾ D4: ___ ²⁾	D1: 500 ms D2: 500 ms D3: ___ ²⁾ D4: ___ ²⁾	D1: 500 ms D2: 500 ms D3: ___ ²⁾ D4: ___ ²⁾
	3. Fault memory	off; on	D1: on D2: on	D1: on D2: on	D1: on D2: on

Explanatory notes to "4105_2" settings

1) Relay mode:



NC: The relay is **energised** in **normal operation** and deenergised in the alarm state

NO: The relay is **deenergised** in **normal operation** and energised in the alarm state

2) Not used for VDE-AR-N 4105.2018-09

3) Profile naming Refer to "Basic programs" on page 49.

6.2 VDE-AR-N 4105:2011-08

4105_1 Menu:	once 	twice 	Profile
Exit			
1. General	Exit		
	1. Standard	4105_2; 4105_1; 4110; BDEW; 0126; CEI021; C10/11; G98; G83/2; G99; G59/2	
	2. Coupling	1 AC; 3N AC; 3 AC	3N AC
	3. U _(L-N) U _(L-L)	50...260 V; 87...450 V	U(L-N) 230 V
	4. t _{SHORT INT.}	off; 40 ms...60 min	3.00 s
	5. t _{(ON) SHORT INT.}	40 ms...60 min	5.00 s
	6. t _{(ON) NORMAL}	40 ms...60 min	60 s
	7. Remote trip	NC; NO; off	off
2. Voltage	Exit		
	1. U>>	off; 100...150 %	115 %
	2. t _(OFF)	40 ms...60 min	100 ms
	3. U>	off; 100...150 %	110 %
	4. t _(OFF)	40 ms...60 min	100 ms
	5. U _{(ON) MAX}	off; 100...150 %	off
	6. U _{(ON) MIN}	off; 1...100 %	85 %
	7. U<	off; 1...100 %	80 %
	8. t _(OFF)	40 ms...60 min	100 ms
	9. U<<	off; 1...100 %	off
	10. t _(OFF)	40 ms...60 min	---
3. Frequency	Exit		
	1. f>>	off; 50.00...65.00 Hz	off
	2. t _(OFF)	40 ms...60 min	---
	3. f>	off; 50.00...65.00 Hz	51.50 Hz
	4. t _(OFF)	40 ms...60 min	100 ms
	5. f _{(ON) MAX}	off; 50.00...65.00 Hz	50.05 Hz
	6. f _{(ON) MIN}	off; 45.00...60.00 Hz	off
	7. f<	off; 45.00...60.00 Hz	47.50 Hz
	8. t _(OFF)	40 ms...60 min	100 ms
	9. f<<	off; 45.00...60.00 Hz	off
	10. t _(OFF)	40 ms...60 min	---

4105_1 Menu:	once ↙	twice ↙	Profile
4. df/dt	Exit		
	1. Function	off; on	off
	2. Resp. value	0.05 ... 9.95 Hz/s	1.00 Hz/s
	3. Hysteresis	1.0 ... 50.0 %	20.0 %
	4. Meas. window	50 ms ... 1 s	200 ms
	5. t _(OFF)	40 ms ... 60 min	100 ms
5. Vect.shift	6. t _(ON)	off; 40 ms ... 60 min	off
	Exit		
	1. Function	off; L1; L2; L3; single; all	off
	2. Resp. value	1.0 ... 25.0 °	8.0 °
	3. t _(START-UP)	off; 40 ms ... 60 min	2.00 s
6. Unbalance	4. t _(ON)	off; 40 ms ... 60 min	off
	Exit		
	1. Function	off; on	off
	2. Resp. value	1.0 ... 50.0 %	5.0 %
	3. Hysteresis	1.0 ... 50.0 %	20.0 %
7. Relays	4. t _(OFF)	40 ms ... 60 min	100 ms
	Exit		
	1. Relay mode ¹⁾	NC; NO	K1: NC K2: NC
8. Dig. input	Exit		
	1. Mode	NC; NO; off	D1: NC D2: NC D3; D4: --- ²⁾
	2. t _(START-UP)	40 ms ... 60 min	D1: 500 ms D2: 500 ms D3; D4: --- ²⁾
	3. Fault memory	off; on	D1: off D2: off D3; D4: --- ²⁾

Explanatory notes to "4105_1" settings



1) Relay mode:

NC: The relay is **energised** in **normal operation** and deenergised in the alarm state

NO: The relay is **deenergised** in **normal operation** and energised in the alarm state

2) Not used for VDE-AR-N 4105:2011-08

6.3 VDE-AR-N 4110:2018-11

4110 Menu :	once 	twice 	Profile 1 ³⁾	Profile 2 ³⁾	Profile 3 ³⁾	Profile 4 ³⁾
Exit						
1. General	Exit					
	1. Standard	4105_2; 4105_1; 4110; BDEW; 0126; CEI021; C10/11; G98; G83/2; G99; G59/2	4110	4110	4110	4110
	2. Profile	1...4	1	2	3	4
	3. Coupling	1 AC; 3N AC; 3 AC	3 AC	3 AC	3 AC	3 AC
	4. U _(L-N) / U _(L-L)	50...260 V; 87...450 V	U(L-L) 398 V	U(L-L) 398 V	U(L-L) 398 V	U(L-L) 398 V
	5. t _{SHORT INT.}	off; 40 ms...60 min	off	off	off	off
	6. t _{(ON) SHORT INT.}	40 ms...60 min	---	---	---	---
	7. t _{(ON) NORMAL}	40 ms...60 min	10 min	10 min	10 min	10 min
	8. Remote trip	NC; NO; off	off	off	off	off
2. Voltage	Exit					
	1. U>>	off; 100...150 %	120 %	125 %	120 %	125 %
	2. t _(OFF)	40 ms...60 min	300 ms	300 ms	300 ms	300 ms
	3. U>	off; 100...150 %	110 %	off	110 %	off
	4. t _(OFF)	40 ms...60 min	180 s	---	180 s	---
	5. U _{(ON) MAX}	off; 100...150 %	off	110 %	off	110 %
	6. U _{(ON) MIN}	off; 1...100 %	90 %	95 %	90 %	95 %
	7. U<	off; 1...100 %	80 %	80 %	80 %	80 %
	8. t _(OFF)	40 ms...60 min	2.7 s	1.50 s	2.7 s	1.00 s
	9. U<<	off; 1...100 %	off	30 %	off	45 %
	10. t _(OFF)	40 ms...60 min	---	800 ms	---	300 ms
3. Frequency	Exit					
	1. f>>	off; 50.00...65.00 Hz	off	52.50 Hz	off	52.50 Hz
	2. t _(OFF)	40 ms...60 min	---	100 ms	---	100 ms
	3. f>	off; 50.00...65.00 Hz	off	51.50 Hz	off	51.50 Hz
	4. t _(OFF)	40 ms...60 min	---	5.0 s	---	5.0 s
	5. f _{(ON) MAX}	off; 50.00...65.00 Hz	50.20 Hz	50.10 Hz	50.20 Hz	50.10 Hz
	6. f _{(ON) MIN}	off; 45.00...60.00 Hz	47.50 Hz	49.90 Hz	47.50 Hz	49.90 Hz
	7. f<	off; 45.00...60.00 Hz	off	47.50 Hz	off	47.50 Hz
	8. t _(OFF)	40 ms...60 min	---	100 ms	---	100 ms
	9. f<<	off; 45.00...60.00 Hz	off	off	off	off
	10. t _(OFF)	40 ms...60 min	---	---	---	---

4110 Menu :	once ↙	twice ↙	Profile 1 ³⁾	Profile 2 ³⁾	Profile 3 ³⁾	Profile 4 ³⁾
4. df/dt	Exit					
	1. Function	off; on	off	off	off	off
	2. Resp. value	0.05...9.95 Hz/s	1.00 Hz/s	1.00 Hz/s	1.00 Hz/s	1.00 Hz/s
	3. Hysteresis	1.0...50.0 %	20.0 %	20.0 %	20.0 %	20.0 %
	4. Meas. window	50 ms...1 s	200 ms	200 ms	200 ms	200 ms
	5. t _(OFF)	40 ms...60 min	100 ms	100 ms	100 ms	100 ms
5. Vect.shift	6. t _(ON)	off 40 ms...60 min	off	off	off	off
	Exit					
	1. Function	off; L1; L2; L3; single; all	off	off	off	off
	2. Resp. value	1.0...25.0 °	8.0 °	8.0 °	8.0 °	8.0 °
6. Unbalance	3. t _(START-UP)	off; 40 ms...60 min	2.00 s	2.00 s	2.00 s	2.00 s
	4. t _(ON)	off; 40 ms...60 min	off	off	off	off
	Exit					
	1. Function	off; on	off	off	off	off
7. Relays	2. Resp. value	1.0...50.0 %	5.0 %	5.0 %	5.0 %	5.0 %
	3. Hysteresis	1.0...50.0 %	20.0 %	20.0 %	20.0 %	20.0 %
	4. t _(OFF)	40 ms...60 min	100 ms	100 ms	100 ms	100 ms
	Exit					
8. Dig. input	1. Relay mode ¹⁾	NC; NO	K1: NC K2: NC	K1: NC K2: NC	K1: NC K2: NC	K1: NC K2: NC
	Exit					
1. Mode	NC; NO; off	D1: off D2: off D3; D4: --- ²⁾	D1: off D2: off D3; D4: --- ²⁾	D1: off D2: off D3; D4: --- ²⁾	D1: off D2: off D3; D4: --- ²⁾	D1: off D2: off D3; D4: --- ²⁾
	2. t _(START-UP)	40 ms...60 min	D1: --- D2: --- D3; D4: --- ²⁾	D1: --- D2: --- D3; D4: --- ²⁾	D1: --- D2: --- D3; D4: --- ²⁾	D1: --- D2: --- D3; D4: --- ²⁾
	3. Fault memory	off; on	D1: off D2: off D3; D4: --- ²⁾	D1: off D2: off D3; D4: --- ²⁾	D1: off D2: off D3; D4: --- ²⁾	D1: off D2: off D3; D4: --- ²⁾

Explanatory notes to "4110" settings

1) Relay mode:



NC: The relay is **energised** in **normal operation** and deenergised in the alarm state

NO: The relay is **deenergised** in **normal operation** and energised in the alarm state

2) Not used for VDE-AR-N 4110:2018-11

3) Profile naming Refer to "Basic programs" on page 49.

6.4 BDEW guideline 2008

BDEW menu: Settings	once 	twice 	Factory setting
Exit			
1. General	Exit		
	1. Standard	4105_2; 4105_1; 4110; BDEW; 0126; CEI021; C10/11; G98; G83/2; G99; G59/2	
	2. Coupling	1 AC; 3N AC; 3 AC	3N AC
	3. $U_{(L-N)}$ $U_{(L-L)}$	50...260 V; 87...450 V	$U_{(L-N)}$ 230 V
	4. $t_{SHORT INT.}$	off; 40 ms...60 min	off
	5. $t_{(ON) SHORT INT.}$	40 ms...60 min	---
	6. $t_{(ON) NORMAL}$	40 ms...60 min	30 s
	7. Remote trip	NC; NO; off	off
2. Voltage	Exit		
	1. $U >>$	off; 100...150 %	120 %
	2. $t_{(OFF)}$	40 ms...60 min	100 ms
	3. $U >$	off; 100...150 %	108 %
	4. $t_{(OFF)}$	40 ms...60 min	60 s
	5. $U_{(ON) MAX}$	off; 100...150 %	off
	6. $U_{(ON) MIN}$	off; 1...100 %	95 %
	7. $U <$	off; 1...100 %	80 %
	8. $t_{(OFF)}$	40 ms...60 min	2.40 s
	9. $U <<$	off; 1...100 %	45 %
	10. $t_{(OFF)}$	40 ms...60 min	300 ms
3. Frequency	Exit		
	1. $f >>$	off; 50.00...65.00 Hz	off
	2. $t_{(OFF)}$	40 ms...60 min	---
	3. $f >$	off; 50.00...65.00 Hz	51.50 Hz
	4. $t_{(OFF)}$	40 ms...60 min	100 ms
	5. $f_{(ON) MAX}$	off; 50.00...65.00 Hz	50.05 Hz
	6. $f_{(ON) MIN}$	off; 45.00...60.00 Hz	off
	7. $f <$	off; 45.00...60.00 Hz	47.50 Hz
	8. $t_{(OFF)}$	40 ms...60 min	100 ms
	9. $f <<$	off; 45.00...60.00 Hz	off
	10. $t_{(OFF)}$	40 ms...60 min	---

BDEW menu: Settings	once ↙	twice ↙	Factory setting
4. df/dt	Exit		
	1. Function	off; on	off
	2. Resp. value	0.05...9.95 Hz/s	1.00 Hz/s
	3. Hysteresis	1.0...50.0 %	20.0 %
	4. Meas. window	50 ms...1 s	200 ms
	5. t _(OFF)	40 ms...60 min	100 ms
5. Vect.shift	6. t _(ON)	off 40 ms...60 min	off
	Exit		
	1. Function	off; L1; L2; L3; single; all	off
	2. Resp. value	1.0...25.0°	8.0°
6. Unbalance	3. t _(START-UP)	off; 40 ms...60 min	2.00 s
	4. t _(ON)	off; 40 ms...60 min	off
	Exit		
	1. Function	off; on	off
7. Relays	2. Resp. value	1.0...50.0 %	5.0 %
	3. Hysteresis	1.0...50.0 %	20.0 %
	4. t _(OFF)	40 ms...60 min	100 ms
	1. Relay mode ¹⁾	NC; NO	K1: NC K2: NC
8. Dig. input	Exit		
	1. Mode	NC; NO; off	D1: off D2: off D3; D4: --- ²⁾
	2. t _(START-UP)	40 ms...60 min	D1: -- D2: -- D3; D4: --- ²⁾
	3. Fault memory	off; on	D1: off D2: off D3; D4: --- ²⁾

Explanatory notes to "BDEW" settings

1) Relay mode:

NC: The relay is **energised** in **normal operation** and deenergised in the alarm state

NO: The relay is **deenergised** in **normal operation** and energised in the alarm state

2) Not used for BDEW guideline 2008

6.5 DIN V VDE V 0126-1-1:2006-02/A1:2012-02

0126 Menu :	once ↙	twice ↙	Profile
Exit			
1. General	Exit		
	1. Standard	4105_2, 4105_1, 4110, BDEW, 0126, CEI021, C10/11, G98, G83/2, G99, G59/2	0126
	2. Coupling	1 AC; 3N AC; 3 AC	3N AC
	3. $U_{(L-N)}$ $U_{(L-L)}$	50...260 V; 87...450 V	$U_{(L-N)}$ 230 V
	4. $t_{SHORT INT.}$	off; 40 ms...60 min	3.00 s
	5. $t_{(ON) SHORT INT.}$	40 ms...60 min	5.00 s
	6. $t_{(ON) NORMAL}$	40 ms...60 min	30 s
	7. Remote trip	NC; NO; off	off
2. Voltage	Exit		
	1. $U >>$	off; 100...150 %	115 %
	2. $t_{(OFF)}$	40 ms...60 min	100 ms
	3. $U >$	off; 100...150 %	110 %
	4. $t_{(OFF)}$	40 ms...60 min	100 ms
	5. $U_{(ON) MAX}$	off; 100...150 %	off
	6. $U_{(ON) MIN}$	off; 1...100 %	off
	7. $U <$	off; 1...100 %	80 %
	8. $t_{(OFF)}$	40 ms...60 min	100 ms
	9. $U <<$	off; 1...100 %	off
	10. $t_{(OFF)}$	40 ms...60 min	--
	3. Frequency	Exit	
1. $f >>$		off; 50.00...65.00 Hz	off
2. $t_{(OFF)}$		40 ms...60 min	--
3. $f >$		off; 50.00...65.00 Hz	51.50 Hz
4. $t_{(OFF)}$		40 ms...60 min	100 ms
5. $f_{(ON) MAX}$		off; 50.00...65.00 Hz	off
6. $f_{(ON) MIN}$		off; 45.00...60.00 Hz	off
7. $f <$		off; 45.00...60.00 Hz	47.50 Hz
8. $t_{(OFF)}$		40 ms...60 min	100 ms
9. $f <<$		off; 45.00...60.00 Hz	off
10. $t_{(OFF)}$		40 ms...60 min	--

0126 Menu :	once ↙	twice ↙	Profile
4. df/dt	Exit		
	1. Function	off; on	off
	2. Resp. value	0.05 ... 9.95 Hz/s	1.00 Hz/s
	3. Hysteresis	1.0 ... 50.0 %	20.0 %
	4. Meas. window	50 ms ... 1 s	200 ms
	5. t _(OFF)	40 ms ... 60 min	100 ms
5. Vect.shift	6. t _(ON)	off 40 ms ... 60 min	off
	Exit		
	1. Function	off; L1; L2; L3; single; all	off
	2. Resp. value	1.0 ... 25.0 °	8.0 °
6. Unbalance	3. t _(START-UP)	off; 40 ms ... 60 min	2.00 s
	4. t _(ON)	off; 40 ms ... 60 min	off
	Exit		
	1. Function	off; on	off
7. Relays	2. Resp. value	1.0 ... 50.0 %	5.0 %
	3. Hysteresis	1.0 ... 50.0 %	20.0 %
	4. t _(OFF)	40 ms ... 60 min	100 ms
	Exit		
8. Dig. input	1. Relay mode ¹⁾	NC; NO	K1: NC K2: NC
	Exit		
	1. Mode	NC; NO; off	D1: NC D2: NC D3; D4: --- ²⁾
2. t _(START-UP)	40 ms ... 60 min	D1: 500 ms D2: 500 ms D3; D4: --- ²⁾	
	3. Fault memory	off; on	D1: off D2: off D3; D4: --- ²⁾

Explanatory notes to "0126" settings



1) Relay mode:

NC: The relay is **energised** in **normal operation** and deenergised in the alarm state

NO: The relay is **deenergised** in **normal operation** and energised in the alarm state

2) Not used for DIN V VDE V 0126-1-1

6.6 CEI 0-21 (:2012-06, :V1:2012-12, :V2:2013-12, :2014-09, :V1:2014-12; 2016-07, V1:2017-07)

CEI 0-21 menu:	once 	twice 	Factory setting
Exit			
1. General	Exit		
	1. Standard	4105_2, 4105_1, 4110, BDEW, 0126, CEI021, C10/11, G98, G83/2, G99, G59/2	CEI021
	2. Coupling	1 AC; 3N AC; 3 AC	3N AC
	3. $U_{(L-N)} / U_{(L-L)}$	50...260 V; 87...450 V	$U_{(L-N)}$ 230 V
	4. Mode	off/external ¹⁾ / local ²⁾	off
	5. $t_{SHORT INT.}$	off/40 ms...60 min	off
	6. $t_{(ON) SHORT INT.}$	40 ms...60 min	--
	7. $t_{(ON) NORMAL}$	40 ms...60 min	70 ms
8. Remote trip	NC; NO; off	NC	
2. Voltage	Exit		
	1. $U_{>>}$ (59.52)	off/100...150 %	115 %
	2. $t_{(OFF)}$ (59.52)	40 ms...60 min	200 ms
	3. $U_{>}$ (59.51)	off/100...150 %	110 %
	4. $t_{(OFF)}$ (59.51)	40 ms...60 min	3.00 s
	5. $U_{(ON) MAX}$	off/100...150 %	off ¹⁾
	6. $U_{(ON) MIN}$	off/1...100 %	off ¹⁾
	7. $U_{<}$ (27.51)	off/1...100 %	85 %
	8. $t_{(OFF)}$ (27.51)	40 ms...60 min	400 ms
	9. $U_{<<}$ (27.52)	off/1...100 %	40 %
	10. $t_{(OFF)}$ (27.52)	40 ms...60 min	200 ms

CEI 0-21 menu:	once ↙	twice ↙	Factory setting
3. Frequency	Exit		
	1. f>>	off/50.00...65.00 Hz	off
	2. t _(OFF)	40 ms...60 min	---
	3. f> (81>.S1)	off/50.00...65.00 Hz	50.50 Hz
	4. t _(OFF) (81>.S1)	40 ms...60 min	100 ms
	5. f _(ON) MAX	off/50.00...65.00 Hz	off ¹⁾
	6. f _(ON) MIN	off/45.00...60.00 Hz	off ¹⁾
	7. f< (81<.S1)	off/45.00...60.00 Hz	49.50 Hz
	8. t _(OFF) (81<.S1)	40 ms...60 min	100 ms
	9. f> (81>.S2)	off/50.00...65.00 Hz	51.50 Hz
	10. f< (81<.S2)	off/50.00...65.00 Hz	47.50 Hz
	11. Tlc (off) (81>.S2)	40 ms...60 min	100 ms
	12. Tlc (off) (81>.S2)	40 ms...60 min	100 ms
13. Tex (off) (81>.S2)	40 ms...60 min	1.00 s	
3. Frequency	14. Tex (off) (81<.S2)	40 ms...60 min	4.00 s
	15. f<<	off; 45.00...60.00 Hz	off
	16. t _(OFF)	40 ms...60 min	---
4. df/dt	Exit		
	1. Function	off/on	off
	2. Resp. value	0.05...9.95 Hz/s	1.00 Hz/s
	3. Hysteresis	1.0...50.0 %	20.0 %
	4. Meas. window	50 ms...1 s	200 ms
	5. t _(OFF)	40 ms...60 min	100 ms
	6. t _(ON)	off; 40 ms...60 min	30 s
5. Vect.shift	Exit		
	1. Function	off; L1; L2; L3; single; all	off
	2. Resp. value	1.0...25.0 °	8.0 °
	3. t _(START-UP)	off/40 ms...60 min	2.00 s
	4. t _(ON)	off/40 ms...60 min	30 s
6. Unbalance	Exit		
	1. Function	off/on	off
	2. Resp. value	1.0...50.0 %	5.0 %
	3. Hysteresis	1.0...50.0 %	20.0 %
	4. t _(OFF)	40 ms...60 min	100 ms
7. Relays	Exit		
	1. Relay mode ²⁾	NC; NO	K1: NC K2: NO

CEI 0-21 menu:	once ↙	twice ↙	Factory setting
8. Dig. input	Exit		
D1: K1 D2: K2 (backup) D3: local control D4: external signal	1. Mode	NC; NO; off	D1: NC D2: off D3: NO D4: NO
	2. $t_{(START-UP)}$	40 ms... 60 min	D1: 500 ms D2: --- D3; D4: --- ³⁾
	3. Fault memory	off; on	D1: off D2: off D3; D4: --- ³⁾

Explanatory notes to "0126" settings

¹⁾ The CEI0-21 standard uses a fixed factor applied to the response value instead of separate (re)connection conditions. (Hysteresis)

The factors are:

Overvoltage: x 0.96;

Undervoltage: x 1.04;

Overfrequency: x 0.998;

Underfrequency: x 1.002.

The behaviour only applies if the parameters U(ON)min, U(ON)max, f(ON)min and f(ON)max are set to "off".

²⁾ Relay mode:

NC: The relay is **energised** in **normal operation** and deenergised in the alarm state

NO: The relay is **deenergised** in **normal operation** and energised in the alarm state

³⁾ Not used for CEI 0-21(:2012-06, :V1:2012-12, :V2:2013-12, :2014-09, :V1:2014-12)

6.7 C10/11:2006-06

C10/11 Menu:	once ↙	twice ↙	Profile
Exit			
1. General	Exit		
	1. Standard	4105_2; 4105_1; 4110; BDEW; 0126; CEI021; C10/11; G98; G83/2; G99; G59/2	C10/11
	2. Coupling	1 AC; 3N AC; 3 AC	3N AC
	3. U _(L-N) U _(L-L)	50...260 V; 87...450 V	U(L-N) 230 V
	4. t _{SHORT INT.}	off; 40 ms...60 min	3.00 s
	5. t _{(ON) SHORT INT.}	40 ms...60 min	5.00 s
	6. t _{(ON) NORMAL}	40 ms...60 min	60 s
	7. Remote trip	NC; NO; off	off
2. Voltage	Exit		
	1. U>>	off; 100...150 %	115 %
	2. t _(OFF)	40 ms...60 min	100 ms
	3. U>	off; 100...150 %	110 %
	4. t _(OFF)	40 ms...60 min	100 ms
	5. U _{(ON) MAX}	off; 100...150 %	off
	6. U _{(ON) MIN}	off; 1...100 %	85 %
	7. U<	off; 1...100 %	80 %
	8. t _(OFF)	40 ms...60 min	100 ms
	9. U<<	off; 1...100 %	off
	10. t _(OFF)	40 ms...60 min	--
3. Frequency	Exit		
	1. f>>	off; 50.00...65.00 Hz	off
	2. t _(OFF)	40 ms...60 min	--
	3. f>	off; 50.00...65.00 Hz	51.50 Hz
	4. t _(OFF)	40 ms...60 min	100 ms
	5. f _{(ON) MAX}	off; 50.00...65.00 Hz	50.05 Hz
	6. f _{(ON) MIN}	off; 45.00...60.00 Hz	off
	7. f<	off; 45.00...60.00 Hz	47.50 Hz
	8. t _(OFF)	40 ms...60 min	100 ms
	9. f<<	off; 45.00...60.00 Hz	off
	10. t _(OFF)	40 ms...60 min	--

C10/11 Menu:	once ↓	twice ↓	Profile
4. df/dt	Exit		
	1. Function	off; on	on
	2. Resp. value	0.05...9.95 Hz/s	1.00 Hz/s
	3. Hysteresis	1.0...50.0 %	20.0 %
	4. Meas. window	50 ms...1 s	200 ms
	5. t _(OFF)	40 ms...60 min	100 ms
5. Vect.shift	6. t _(ON)	off; 40 ms...60 min	off
	Exit		
	1. Function	off; L1; L2; L3; single; all	off
	2. Resp. value	1.0...25.0°	8.0°
6. Unbalance	3. t _(START-UP)	off; 40 ms...60 min	2.00 s
	4. t _(ON)	off; 40 ms...60 min	off
	Exit		
	1. Function	off; on	off
7. Relays	2. Resp. value	1.0...50.0 %	5.0 %
	3. Hysteresis	1.0...50.0 %	20.0 %
	4. t _(OFF)	40 ms...60 min	100 ms
	Exit		
8. Dig. input	1. Relay mode ¹⁾	NC; NO	K1: NC K2: NC
	1. Mode	NC; NO; off	D1: NC D2: NC D3; D4: --- ²⁾
	2. t _(START-UP)	40 ms...60 min	D1: 500 ms D2: 500 ms D3; D4: --- ²⁾
	3. Fault memory	off; on	D1: off D2: off D3; D4: --- ²⁾

Explanatory notes to "C10/11" settings

1) Relay mode:

NC: The relay is **energised** in **normal operation** and deenergised in the alarm state

NO: The relay is **deenergised** in **normal operation** and energised in the alarm state

2) Not used for C10/11

6.8 G98/1-4:2019

G98 menu:	once ↵	twice ↵	Factory setting
Exit			
1. General	Exit		
	1. Standard	4105_2; 4105_1; 4110; BDEW; 0126; CEI021; C10/11; G98; G83/2; G99; G59/2	G98
	2. Coupling	1 AC; 3N AC; 3 AC	3N AC
	3. $U_{(L-N)} / U_{(L-L)}$	50...260 V; 87...450 V	U(L-N) 230 V
	4. $t_{\text{SHORT INT.}}$	off; 40 ms...60 min	off
	5. $t_{\text{(ON) SHORT INT.}}$	40 ms...60 min	---
	6. $t_{\text{(ON) NORMAL}}$	40 ms...60 min	20 s
	7. Remote trip	NC; NO; off	off
2. Voltage	Exit		
	1. $U >>$	off; 100...150 %	119 %
	2. $t_{\text{(OFF)}}$	40 ms...60 min	500 ms
	3. $U >$	off; 100...150 %	114 %
	4. $t_{\text{(OFF)}}$	40 ms...60 min	1.00 s
	5. $U_{\text{(ON) MAX}}$	off; 100...150 %	off
	6. $U_{\text{(ON) MIN}}$	off; 1...100 %	off
	7. $U <$	off; 1...100 %	80 %
	8. $t_{\text{(OFF)}}$	40 ms...60 min	2.50 s
	9. $U <<$	off; 1...100 %	off
	10. $t_{\text{(OFF)}}$	40 ms...60 min	---
3. Frequency	Exit		
	1. $f >>$	off; 50.00...65.00 Hz	off
	2. $t_{\text{(OFF)}}$	40 ms...60 min	---
	3. $f >$	off; 50.00...65.00 Hz	52Hz
	4. $t_{\text{(OFF)}}$	40 ms...60 min	500 ms
	5. $f_{\text{(ON) MAX}}$	off; 50.00...65.00 Hz	off
	6. $f_{\text{(ON) MIN}}$	off; 45.00...60.00 Hz	off
	7. $f <$	off; 45.00...60.00 Hz	47.50 Hz
	8. $t_{\text{(OFF)}}$	40 ms...60 min	20 s
	9. $f <<$	off; 45.00...60.00 Hz	47.00 Hz
	10. $t_{\text{(OFF)}}$	40 ms...60 min	500 ms

G98 menu:	once ↙	twice ↙	Factory setting
4. df/dt	Exit		
	1. Function	off; on	on
	2. Resp. value	0.05 ... 9.95 Hz/s	1.00 Hz/s
	3. Hysteresis	1.0 ... 50.0 %	20.0 %
	4. Meas. window	50 ms ... 1 s	500 ms
	5. t _(OFF)	40 ms ... 60 min	100 ms
6. t _(ON)	off; 40 ms ... 60 min	off	
	5. Vect.shift	Exit	
	1. Function	off; L1; L2; L3; single; all	off
	2. Resp. value	1.0 ... 25.0°	12.0°
3. t _(START-UP)	off; 40 ms ... 60 min	2.00 s	
	4. t _(ON)	off; 40 ms ... 60 min	off
	6. Unbalance	Exit	
	1. Function	off; on	off
2. Resp. value	1.0 ... 50.0 %	5.0 %	
3. Hysteresis	1.0 ... 50.0 %	20.0 %	
4. t _(OFF)	40 ms ... 60 min	100 ms	
7. Relays	Exit		
1. Relay mode ¹⁾	NC; NO	K1: NC K2: NC	
8. Dig. input	Exit		
	1. Mode	NC; NO; off	D1: NC D2: NC D3; D4: --- ²⁾
	2. t _(START-UP)	40 ms ... 60 min	D1: 500 ms D2: 500 ms D3; D4: --- ²⁾
3. Fault memory	off; on	D1: off D2: off D3; D4: --- ²⁾	

Explanatory notes to "G98" settings

1) Relay mode:

NC: The relay is **energised** in **normal operation** and deenergised in the alarm state



NO: The relay is **deenergised** in **normal operation** and energised in the alarm state

2) Not used for G98/1-4:2019

6.9 G59/3:2013, G83/2:2012

The factory settings are the same for both of the guidelines G59/3 and G83/2.

G59/3, G83/2 menu:	once ↙	twice ↙	Factory setting
Exit			
1. General	Exit		
	1. Standard	4105_2; 4105_1; 4110; BDEW; 0126; CEI021; C10/11; G98; G83/2; G99; G59/2	G83/2
	2. Coupling	1 AC; 3N AC; 3 AC	3N AC
	3. $U_{(L-N)}$ $U_{(L-L)}$	50...260 V; 87...450 V	U(L-N) 230 V
	4. $t_{SHORT INT.}$	off; 40 ms...60 min	off
	5. $t_{(ON) SHORT INT.}$	40 ms...60 min	—
	6. $t_{(ON) NORMAL}$	40 ms...60 min	20 s
	7. Remote trip	NC; NO; off	off
2. Voltage	Exit		
	1. $U >>$	off; 100...150 %	119 %
	2. $t_{(OFF)}$	40 ms...60 min	500 ms
	3. $U >$	off; 100...150 %	114 %
	4. $t_{(OFF)}$	40 ms...60 min	1.00 s
	5. $U_{(ON) MAX}$	off; 100...150 %	off
	6. $U_{(ON) MIN}$	off; 1...100 %	off
	7. $U <$	off; 1...100 %	87 %
	8. $t_{(OFF)}$	40 ms...60 min	2.50 s
	9. $U <<$	off; 1...100 %	80 %
	10. $t_{(OFF)}$	40 ms...60 min	500 ms
3. Frequency	Exit		
	1. $f >>$	off; 50.00...65.00 Hz	52.00 Hz
	2. $t_{(OFF)}$	40 ms...60 min	500 ms
	3. $f >$	off; 50.00...65.00 Hz	51.50 Hz
	4. $t_{(OFF)}$	40 ms...60 min	90 s
	5. $f_{(ON) MAX}$	off; 50.00...65.00 Hz	off
	6. $f_{(ON) MIN}$	off; 45.00...60.00 Hz	off
	7. $f <$	off; 45.00...60.00 Hz	47.50 Hz
	8. $t_{(OFF)}$	40 ms...60 min	20 s
	9. $f <<$	off; 45.00...60.00 Hz	47.00 Hz
	10. $t_{(OFF)}$	40 ms...60 min	500 ms

G59/3, G83/2 menu:	once 	twice 	Factory setting
4. df/dt	Exit		
	1. Function	off; on	off
	2. Resp. value	0.05 ... 9.95 Hz/s	1.00 Hz/s
	3. Hysteresis	1.0 ... 50.0 %	20.0 %
	4. Meas. window	50 ms ... 1 s	200 ms
	5. t _(OFF)	40 ms ... 60 min	100 ms
5. Vect.shift	Exit		
	1. Function	off; L1; L2; L3; single; all	off
	2. Resp. value	1.0 ... 25.0 °	8.0 °
	3. t _(START-UP)	off; 40 ms ... 60 min	2.00 s
6. Unbalance	Exit		
	1. Function	off; on	off
	2. Resp. value	1.0 ... 50.0 %	5.0 %
	3. Hysteresis	1.0 ... 50.0 %	20.0 %
7. Relays	Exit		
	1. Relay mode ¹⁾	NC; NO	K1: NC K2: NC
8. Dig. input	Exit		
	1. Mode	NC; NO; off	D1: NC D2: NC D3; D4: --- ²⁾
	2. t _(START-UP)	40 ms ... 60 min	D1: 500 ms D2: 500 ms D3; D4: --- ²⁾
	3. Fault memory	off; on	D1: off D2: off D3; D4: --- ²⁾

Explanatory notes to "G59/3, G83/2" settings

1) Relay mode:

NC: The relay is **energised** in **normal operation** and deenergised in the alarm state

NO: The relay is **deenergised** in **normal operation** and energised in the alarm state

2) Not used for G83/2:2012 and G59/3:2013

6.10 G99/1-4:2019

G99 menu:	once ↵	twice ↵	Profile 1 ³⁾	Profile 2 ³⁾	Profile 3 ³⁾
Exit					
1. General	Exit				
	1. Standard	4105_2, 4105_1, 4110, BDEW, 0126, CEI021, C10/11, G98, G83/2 G99, G59/2	G99	G99	G99
	2. Profile	1...3	1	2	3
	3. Coupling	1 AC; 3N AC; 3 AC	3N AC	3N AC	3N AC
	4. $U_{(L-N)} / U_{(L-L)}$	50...260 V; 87...450 V	U(L-N) 230 V	U(L-N) 230 V	U(L-N) 230 V
	5. $t_{\text{SHORT INT.}}$	off; 40 ms...60 min	off	off	off
	6. $t_{(ON) \text{ SHORT INT.}}$	40 ms...60 min	---	---	---
	7. $t_{(ON) \text{ NORMAL}}$	40 ms...60 min	20 s	20 s	20 s
8. Remote trip	NC; NO; off	off	off	off	
2. Voltage	Exit				
	1. $U >>$	off; 100...150 %	119 %	113 %	off
	2. $t_{(OFF)}$	40 ms...60 min	500 ms	500 ms	--
	3. $U >$	off; 100...150 %	114 %	110 %	110 %
	4. $t_{(OFF)}$	40 ms...60 min	1 s	1 s	1 s
	5. $U_{(ON) \text{ MAX}}$	off; 100...150 %	off	off	off
	6. $U_{(ON) \text{ MIN}}$	off; 1...100 %	off	off	off
	7. $U <$	off; 1...100 %	80 %	80 %	80 %
	8. $t_{(OFF)}$	40 ms...60 min	2.50 s	2.50 s	2.50 s
	9. $U <<$	off; 1...100 %	off	off	off
10. $t_{(OFF)}$	40 ms...60 min	---	---	---	
3. Frequency	Exit				
	1. $f >>$	off; 50.00...65.00 Hz	off	off	off
	2. $t_{(OFF)}$	40 ms...60 min	---	---	---
	3. $f >$	off; 50.00...65.00 Hz	52.00 Hz	52.00 Hz	52.00 Hz
	4. $t_{(OFF)}$	40 ms...60 min	500 ms	500 ms	500 ms
	5. $f_{(ON) \text{ MAX}}$	off; 50.00...65.00 Hz	off	off	off
	6. $f_{(ON) \text{ MIN}}$	off; 45.00...60.00 Hz	off	off	off
	7. $f <$	off; 45.00...60.00 Hz	47.50 Hz	47.50 Hz	47.50 Hz
	8. $t_{(OFF)}$	40 ms...60 min	20 s	20 s	20 s
	9. $f <<$	off; 45.00...60.00 Hz	47.00 Hz	47.00 Hz	47.00 Hz
10. $t_{(OFF)}$	40 ms...60 min	500 ms	500 ms	500 ms	

4. df/dt	Exit				
	1. Function	off/on	on	on	on
	2. Resp. value	0.05 ... 9.95 Hz/s	1.00 Hz/s	1.00 Hz/s	1.00 Hz/s
	3. Hysteresis	1.0 ... 50.0 %	20.00 %	20.00 %	20.00 %
	4. Meas. window	50 ms ... 1 s	200 ms	200 ms	200 ms
	5. t _(OFF)	40 ms ... 60 min	500 ms	500 ms	500 ms
5. Vect.shift	6. t _(ON)	off; 40 ms ... 60 min	off	off	off
	Exit				
	1. Function	off; L1; L2; L3; single; all	off	off	off
	2. Resp. value	1.0 ... 25.0 °	12.0 °	12.0 °	12.0 °
	3. t _(START-UP)	off; 40 ms ... 60 min	2.00 s	2.00 s	2.00 s
6. Unbalance	4. t _(ON)	off; 40 ms ... 60 min	off	off	off
	Exit				
	1. Function	off; on	off	off	off
	2. Resp. value	1.0 ... 50.0 %	5.00 %	5.00 %	5.00 %
	3. Hysteresis	1.0 ... 50.0 %	20.00 %	20.00 %	20.00 %
7. Relays	4. t _(OFF)	40 ms ... 60 min	100 ms	100 ms	100 ms
	Exit				
8. Dig. input	1. Relay mode ¹⁾	NC; NO	K1: NC K2: NC	K1: NC K2: NC	K1: NC K2: NC
	Exit				
	1. Mode	NC; NO; off	D1: NC D2: NC D3; D4: --- ²⁾	D1: NC D2: NC D3; D4: --- ²⁾	D1: NC D2: NC D3; D4: --- ²⁾
	2. t _(START-UP)	40 ms ... 60 min	D1: 500 ms D2: 500 ms D3; D4: --- ²⁾	D1: 500 ms D2: 500 ms D3; D4: --- ²⁾	D1: 500 ms D2: 500 ms D3; D4: --- ²⁾
3. Fault memory	off; on		D1: off D2: off D3; D4: --- ²⁾	D1: off D2: off D3; D4: --- ²⁾	D1: off D2: off D3; D4: --- ²⁾

Explanatory notes to "G99" settings

1) Relay mode:

NC: The relay is **energised** in **normal operation** and deenergised in the alarm state



NO: The relay is **deenergised** in **normal operation** and energised in the alarm state

2) Not used for G99/1-4:2019

3) Profile naming Refer to "Basic programs" on page 49.

6.11 G59/2:2010, -1/2011

G59/2 menu:	once ↵	twice ↵	Factory setting
Exit			
1. General	Exit		
	1. Standard	4105_2; 4105_1; 4110; BDEW; 0126; CEI021; C10/11; G98; G83/2; G99; G59/2	G59/2
	2. Coupling	1 AC; 3N AC; 3 AC	3N AC
	3. $U_{(L-N)} / U_{(L-L)}$	50...260 V; 87...450 V	U(L-N) 230 V
	4. $t_{\text{SHORT INT.}}$	off; 40 ms...60 min	off
	5. $t_{\text{(ON) SHORT INT.}}$	40 ms...60 min	---
	6. $t_{\text{(ON) NORMAL}}$	40 ms...60 min	180 s
	7. Remote trip	NC; NO; off	off
2. Voltage	Exit		
	1. $U >>$	off; 100...150 %	115 %
	2. $t_{\text{(OFF)}}$	40 ms...60 min	500 ms
	3. $U >$	off; 100...150 %	110 %
	4. $t_{\text{(OFF)}}$	40 ms...60 min	1.00 s
	5. $U_{\text{(ON) MAX}}$	off; 100...150 %	off
	6. $U_{\text{(ON) MIN}}$	off; 1...100 %	off
	7. $U <$	off; 1...100 %	87 %
	8. $t_{\text{(OFF)}}$	40 ms...60 min	2.50 s
	9. $U <<$	off; 1...100 %	80 %
	10. $t_{\text{(OFF)}}$	40 ms...60 min	500 ms
3. Frequency	Exit		
	1. $f >>$	off; 50.00...65.00 Hz	52.00 Hz
	2. $t_{\text{(OFF)}}$	40 ms...60 min	500 ms
	3. $f >$	off; 50.00...65.00 Hz	51.50 Hz
	4. $t_{\text{(OFF)}}$	40 ms...60 min	90 s
	5. $f_{\text{(ON) MAX}}$	off; 50.00...65.00 Hz	off
	6. $f_{\text{(ON) MIN}}$	off; 45.00...60.00 Hz	off
	7. $f <$	off; 45.00...60.00 Hz	47.50 Hz
	8. $t_{\text{(OFF)}}$	40 ms...60 min	20 s
	9. $f <<$	off; 45.00...60.00 Hz	47.00 Hz
	10. $t_{\text{(OFF)}}$	40 ms...60 min	500 ms

G59/2 menu:	once 	twice 	Factory setting
4. df/dt	Exit		
	1. Function	off; on	off
	2. Resp. value	0.05 ... 9.95 Hz/s	1.00 Hz/s
	3. Hysteresis	1.0 ... 50.0 %	20.0 %
	4. Meas. window	50 ms ... 1 s	200 ms
	5. t _(OFF)	40 ms ... 60 min	100 ms
5. Vect.shift	Exit		
	1. Function	off; L1; L2; L3; single; all	off
	2. Resp. value	1.0 ... 25.0 °	8.0 °
	3. t _(START-UP)	off; 40 ms ... 60 min	2.00 s
6. Unbalance	Exit		
	1. Function	off; on	off
	2. Resp. value	1.0 ... 50.0 %	5.0 %
	3. Hysteresis	1.0 ... 50.0 %	20.0 %
7. Relays	Exit		
	1. Relay mode ¹⁾	NC; NO	K1: NC K2: NC
8. Dig. input	Exit		
	1. Mode	NC; NO; off	D1: NC D2: NC D3; D4: --- ²⁾
	2. t _(START-UP)	40 ms ... 60 min	D1: 500 ms D2: 500 ms D3; D4: --- ²⁾
	3. Fault memory	off; on	D1: off D2: off D3; D4: --- ²⁾

Explanatory notes to "G59/2" settings

1) Relay mode:

NC: The relay is **energised** in **normal operation** and deenergised in the alarm state

NO: The relay is **deenergised** in **normal operation** and energised in the alarm state

2) Not used for G59/2:2010, -1/2011

7. Maintenance, troubleshooting, messages

7.1 Recurrent test of the tripping circuit by the system operator

The system operator must ensure that the equipment required for parallel operation with the low-voltage network is always in proper technical condition. To this end, it is required to have an electrically skilled person check the protective devices for proper functioning at regular intervals. This requirement is deemed to be satisfied for normal and environmental conditions if the test intervals mentioned in DGUV-V3 are adhered to. The recurrent tests must include at least the following:

- Testing the environmental conditions for pollution, mechanical damage or insulation damage.
- Tripping control of the interface switch.
- Press the "TEST" button to trigger the interface switch.
- Successful activation must be visualised by the interface switch.

The tripping circuit NS protection/interface switch, in the wiring diagram of this operating manual consisting of K1/K2 and interface switch 1/interface switch 2, disconnects the generating plant from the public low-voltage network. By checking the tripping circuit regularly, sticking of the contactor contacts can be detected at an early stage.

7.2 Manual self test

The self test can only be started manually when the generating plant has been connected by the VMD460-NA (both alarm LEDs off) and an undervoltage limit value has been set.



Both interface switches are disconnected during the self test.

Start of the manual self test:

1. Press the test button on the standard display (> 1.5 s) or
2. Select 4. System --> 7. Test in the menu.

The output relays K1 and K2 switch during the self test and open or close the contacts 11/12/14 and 21/22/24.

At least one undervoltage limit value must have been set because a measured value of 0 V is simulated at L_{1-N} for the duration of the self test. The test continues until the disconnection time for "Undervoltage" $t_{(OFF)}$ has elapsed but no more than two minutes.

- During the self test, the time is measured that passes until the disconnection command is given by the VMD460-NA ($t_{(OFF) \text{ DEVICE}}$).
- When contact monitoring is activated for K1, the time until the interface switch K1 has actually disconnected is additionally measured ($t_{(OFF) \text{ TOT}}$).

The times measured will be indicated on the display as an alarm for 10 seconds. In addition, the times can be viewed in the *Menu: 1. Alarm/measured values* under channel 16 ($t_{(OFF) \text{ TOT}}$) and channel 17 ($t_{(OFF) \text{ DEVICE}}$).

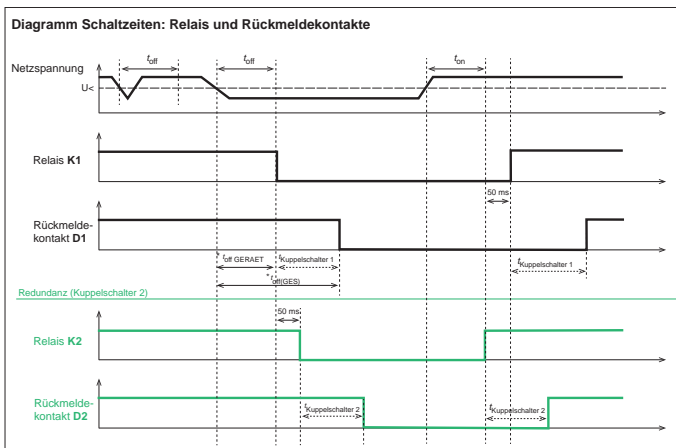

Fig. 7.1: Comments on the timing diagram:

- Times (*) are measured during the self test
 - $t_{(OFF) \text{ DEVICE}}$ is the disconnection time of the VMD460-NA;
 - $t_{(OFF) \text{ TOT}}$ will only be measured when contact monitoring is activated by K1 and has been connected..
- $t_{\text{interface switch 1}} = t_{(OFF) \text{ TOT}} - t_{(OFF) \text{ DEVICE}}$
- All standards (with the exception of CEI 0-21): When disconnecting the generating plant the redundancy (K2) switches to the first interface switch K1 with a delay of 50 ms. After reconnection, K2 closes first and K1 with a delay of 50 ms. In this way, the redundant interface switch is protected, as it always switches free of load.
- As soon as the system voltage exceeds the switching threshold again, the start-up delay $t_{(ON)}$ begins.

7.3 Messages and malfunctions



In case of messages and malfunctions, the generating plant will be disconnected from the public network.

In case of an internal malfunction or an error in the operation of the interface switches, both alarm LEDs flash.

The (error) code or the message is shown in **clear text** on the display.

Code/message	LED	Meaning	Remedy
1...20, 23	Both alarm LEDs flash	Internal error	Write down the error code "xx" and contact the Bender service.
Contact monitoring K1	Both alarm LEDs flash	Error: Contact monitoring K1	Check tripping circuit incl. interface switch Press RESET
Contact monitoring K2		Error: Contact monitoring K2	
Remote trip	Both alarm LEDs light continuously	Remote disconnection active	Connect RTG/RT1 or deactivate input in the menu (off)
Select the standard	Both alarm LEDs light continuously	No standard is selected	Select the application standard from the menu

If **several faults** or messages occur simultaneously, they will be displayed alternately at four-second intervals.

In case of an **internal error**, write down the error code "xx" and contact the Bender service.

7.4 LEDs

The state of the VMD460-NA can be determined by means of the LEDs. The following table provides an overview of the possibilities.

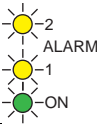
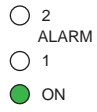
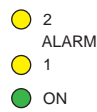
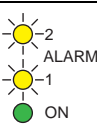
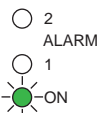
	LEDs	Meaning	Action
 2 ALARM 1 ON	yellow flashes yellow flashes green flashes	Device start	Wait until the device is ready for operation (approx. 5...8 s)
 2 ALARM 1 ON	yellow off yellow off green lights	Normal operation: device in operation, all the measured values are within the specified limits	
 2 ALARM 1 ON	yellow lights yellow lights green lights	Alarm, limit value violated	
 2 ALARM 1 ON	yellow off yellow lights green lights	Alarm stopped, time t_{on} elapses	Wait until the time has elapsed
 2 ALARM 1 ON	yellow flashes yellow flashes green lights	Error contact monitoring or internal error	Check interface switch* ; contact service in case of int. error
 2 ALARM 1 ON	yellow off yellow off green flashes	Internal device error	Contact service

After rectifying the fault at the interface switch/main switch (e.g. manual connection of the backup switch), the fault is automatically cleared.



*If, however, the same fault has occurred three times within 30 seconds, normal operation must be started again after fault rectification by **pressing the "RESET" button** (on the standard display).*

8. Technical data VMD460-NA

() * Factory setting

Insulation coordination acc. to IEC 60664-1/IEC 60664-3

Rated voltage	400 V
Rated impulse voltage/overvoltage category	6 kV/III
Pollution degree	2
Protective separation (reinforced insulation) between.....	(A1, A2) - (L1, L2, L3, N) - (11, 12, 14, 21, 22, 24)
.....	(D1, D2, D3, D4, DG1/2, DG3/4, RTG, RT1)-(A1, A2, L1, L2, L3, N)
Voltage test according to IEC 61010-1: (N, L1, L2, L3) - (A1, A2), (11, 12, 14, 21, 22, 24)	3.32 kV

Supply voltage

Rated supply voltage U_S	AC/DC 100...240 V, DC 50/60 Hz
Operating range U_S	AC/DC 75...300 V, DC 40...70 Hz
Power consumption at AC 230 V	< 7.5 VA/< 3.5 W
.....	max. 9 VA/3.5 W
Bridging time at $U_S = 230$ V and dip to 0 V	600 ms

Measuring circuit

Nominal system voltage U_n (r.m.s. value) (L-N)	AC 0...300 V
Nominal system voltage U_n (r.m.s. value) (L-L)	AC 0...520 V
Input impedance (burden) L1, L2, N	480 k Ω
Input impedance (burden) L3.....	680 k Ω
Rated frequency f_n ($U_n > 20$ V)	45...65 Hz

Response values

System type	1AC: 230 V, 50 Hz
.....	3(N)AC: 400/230 V, 50 Hz
Relative uncertainty, voltage.....	$U \leq 280$ V: ± 1 %
.....	$U > 280$ V: ± 3 %
Resolution of setting voltage	1 %
Rated frequency	50 Hz
Relative uncertainty, frequency	± 0.1 %
Resolution of setting f	0.05 Hz

Recording of measured value, switching condition (reconnection and disconnection)

L-N, L-L	0...1.5 U_n
< f	45...60 Hz
> f	50...65 Hz

Recording of measured value, condition for disconnection:

df/dt	0.05...9.95 Hz/s
-------------	------------------

Time response

Delay time for connection t_{on}	40 ms . . . 60 min
Resolution of setting t_{on}	
< 50 ms:	5 ms
50 . . . 200 ms:	10 ms
200 ms . . . 5 s:	50 ms
5 . . . 10 s:	0.1 s
0 . . . 60 s:	1 s
60 . . . 300 s:	10 s
300 s . . . 60 min:	1 min
Operating time voltage t_{ae}	half a supply period
Operating time, frequency t_{ae}	≤ 40 ms
Recovery time t_b	≤ 300 ms

Digital inputs

Monitoring of potential-free contacts or voltage inputs:	closed = low; 0 . . . 4 V; $I_{in} < -5$ mA
.....	open = high; > 6 . . . 30 V
D1	feedback signal contact K1
D2	feedback signal contact K2
D3	local control (mode)
D4	external signal (mode)
RT1	remote trip
DG1/2, DG3/4, RTG	GND
Max. length of the connecting cables of digital inputs	3 m

Displays, memory

Display	LC display, multi-functional, illuminated
Display range measured value	AC/DC 0 . . . 520 V
Operating uncertainty, voltage.....	$U \leq 280$ V: ± 1 %
.....	$U > 280$ V: ± 3 %
Operating uncertainty, frequency	$\leq \pm 0.1$ %
History memory for the last 300 messages	1 data record measured values each
Password	on/off/0 . . . 999 (off*)

Switching elements

Number of changeover contacts	2 x 1 (K1, K2)
Operating mode	NC operation/NO operation
Electrical endurance under rated operating conditions, number of cycles.....	10,000

Contact data acc. to IEC 60947-5-1:

Utilisation category	AC 13 AC 14 DC-12 DC-12 DC-12
Rated operational voltage	230 V230 V24 V110 V220 V
Rated operational current	4 A**/5 A 3 A 1 A 0.2 A 0.1 A
** Rated operational current for UL508 and CSA C22.2	
Minimum contact rating	10 mA/5 V DC

Environment/EMC

EMC	DIN EN 60255-26 / CEI 0-21
Operating temperature	-25...+55 °C
Classification of climatic conditions acc. to IEC 60721:	
Stationary use (IEC 60721-3-3)	3K23 (except condensation and formation of ice)
Transport (IEC 60721-3-2)	2K11 (except condensation and formation of ice)
Long-term storage (IEC 60721-3-1)	1K22 (except condensation and formation of ice)
Classification of mechanical conditions acc. to IEC 60721:	
Stationary use (IEC 60721-3-3)	3M11
Transport (IEC 60721-3-2)	2M4
Long-term storage (IEC 60721-3-1)	1M22

Connection

Connection type.....	screw-type terminals (or push-wire terminals)
Connection properties:	
Rigid	0.2...4 mm ² (AWG 24...12)
Flexible	0.2...2.5 mm ² (AWG 24...14)
Stripping length.....	8...9 mm
Tightening torque.....	0.5...0.6 Nm (5...7 lb-in)

Other

Operating mode	continuous operation
Mounting	any position
Degree of protection, internal components (DIN EN 60529)	IP30
Degree of protection, terminals (DIN EN 60529)	IP20
Enclosure material	polycarbonate
Flammability class	UL94 V-0
DIN rail mounting acc. to.....	IEC 60715
Screw mounting	2 x M4
Software version measurement technology	D398 V1.4x
Software version display	D403 V2.4x
Weight	≤ 360 g

8.1 Standards, approvals and certifications

Standard/application guide	Explanation
VDE-AR-N 4105:2018-09 (replaces VDE-AR-N4105:2011-08)	Generators connected to the low-voltage distribution network – Technical requirements for the connection to and parallel operation with low-voltage distribution networks
VDE-AR-N 4105:2011-08	Generators connected to the low-voltage distribution network – Technical requirements for the connection to and parallel operation with low-voltage distribution networks
VDE-AR-N 4110:2018-11 (replaces BDEW guideline)	Technical requirements for the connection and operation of customer installations to the medium voltage network (TCR medium voltage)
BDEW technical guideline 2008 with amendments until 01.2013	Technical guideline Generating plants connected to the medium-voltage network; Bundesverband der Energie- und Wasserwirtschaft e.V., Berlin, Juni 2008 (German association of energy and water industries)
DIN V VDE V 0126-1-1:2006-02/A1:2012-02	Automatic disconnection device between a generator and the public low-voltage grid
CEI 0-21(:2012-06, :V1:2012-12, :V2:2013-12, :2014-09, :V1:2014-12; 2016-07, V1:2017-07)	Regola tecnica di riferimento per la connessione di utenti attivi e passivi alle reti BT delle imprese distributrici di energia elettrica) CEI 0-21:2012-06; CEI 0-21 V1:2012-12; CEI 0-21 V2:2013-12; 2016-07; V1:2017-07
C10/11:2012-06	Prescriptions techniques spécifiques de raccordement d'installations de production décentralisée fonctionnant en parallèle sur le réseau de distribution; June 2012
G98/1-4:2019 (replaces G83/2:2012)	Engineering Recommendation G98 - Requirements for the connection of Fully Type Tested Micro-generators (up to and including 16 A per phase) in parallel with public Low Voltage Distribution Networks on or after 27 April 2019
G83/2:2012 and G59/3:2013	Engineering Recommendation G83 - Recommendations for the Connection of Type Tested Small-scale Embedded Generators (Up to 16A per Phase) in Parallel with Low-Voltage Distribution Systems
G99/1-4:2019 (replaces G59/2:2010, -1:2011 and G99/3:2013)	Engineering Recommendation G99 - Requirements for the connection of generation equipment in parallel with public distribution networks on or after 27 April 2019
G59/3:2013	Engineering Recommendation G59 - Recommendations for the Connection of Generating Plant to the Distribution Systems of Licensed Distribution Network Operators
G59/2(:2010, -1:2011)	
UL	File No. E173157

The VMD460-NA has been certified by Bureau Veritas.



8.2 Ordering details

Device type	Nominal voltage U_n	Supply voltage U_s	Art. No.
VMD460-NA-D-2	3(N) AC 400/230 V; 50 Hz	AC/DC 100...240 V; DC 50/60 Hz	B93010045
Mounting clip for screw mounting (1 piece per device, accessories)			B98060008

Device version with push-wire terminals on request.

8.3 Change log

Date	Document-version	Software version	Changes
06/2021	06	D0398 V1.4x	TD: Input impedance (burden), Climatic class 3k5 > 3k23, UKCA Certificate, Design, Change log

A

- Alarm 1 LED lights 40
- Alarm display 41
- Automatic self test 20

B

- Button
 - INFO 43
 - MENU 43
 - RESET 40
 - TEST 40

C

- CEI 0-21
 - Settings 55
 - Wiring diagram 34

D

- Display
 - Alarm 41
 - Info 41
 - Menu 42
 - Toggling between the displays 42

E

- Enter button 40

F

- Factory settings 39

H

- Hazards when handling the device 12
- History 45
- How to use this manual 7

I

- INFO button 43
- Info display 41
- Installation and connection 23
- Intended use 11, 12
- Interface switch 27, 29
- Inverter 27, 29

L

- LEDs 40

M

- Maintenance 49
- Measured values 44
- MENU button 43
- Menu display 42
- Mounting clip for screw mounting 81

N

- Network and system protection 12

O

- Operation and settings 40
- Ordering details 81

P

- Preset function 20

R

- RESET button 40

S

- Safety instructions 11
- Service 7
- Single-fault tolerance 39

- Standard display 41
- Support 7

T

- Technical data 74
- Terminating resistor 27, 29, 33, 38
- TEST button 40
- Timing diagram 75
- Training courses 8

V

- VDE-AR-N 4105
 - Settings 51
 - Wiring diagram 26

W

- Wiring diagram 26
- Workshops 8



Bender GmbH & Co. KG

Postfach 1161 • 35301 Grünberg • Germany
Londorfer Str. 65 • 35305 Grünberg • Germany
Tel.: +49 6401 807-0 • Fax: +49 6401 807-259
E-Mail: info@bender.de • www.bender.de

© Bender GmbH & Co. KG
All rights reserved.
Reproduction only with permission of the publisher.
Subject to alterations!

Photos: Bender archives



BENDER Group